

CARPENTERS-EMPLOYERS
APPRENTICESHIP & TRAINING
TRUST FUND OF WESTERN WASHINGTON

APE Pile Driving School

Topics

- Roman drop hammers
- Pile Types
- Pile Tips & Splices
- Mandrels and Followers
- Leads: Swing, Fixed, Fixed Extended
- Pile Driving Rigs
- Diesel hammers: Single, Double
- Hydraulic impact hammers
- Press Pile Drivers
- Pile Testing
- Pile Inspection
- Pile Cutting
- Vibratory Pile Driver/Extractors
- Noise & Hammers
- Understand Soil Types
- Driven Grout Piles
- Augered Cast-in-Place Piles
- Bored Displacement Piles
- Wick Drains
- Vibroflotation
- Drilled Piles
- Vibro Compaction
- Tie Backs
- Soil Nailing
- Pin Piles
- Anchored Piles
- Jetting
- Air Lifts
- Learning from the Internet
- Crane Signals
- How To Drive & Extract:
 - Wood Piles
 - Concrete Piles
 - Pipe Piles
 - H-Beams
 - Vibrated Beam Slurry Wall
 - Concrete and Wood Sheets
 - Steel Sheets
 - Casings
 - Caissons
 - Power Poles
 - Helicopter
 - Underwater

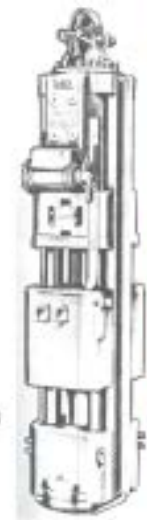

Mallet

Drop hammer

Air/Steam

Diesel

Hydraulic

Vibratory

Single acting

Differential acting

Double acting

Single acting

Double acting

Gravity drop

Assisted drop

Under 2000 rpm

Over 2000 rpm

Variable moment

Hammer classification chart

Hand Held Pile Driver

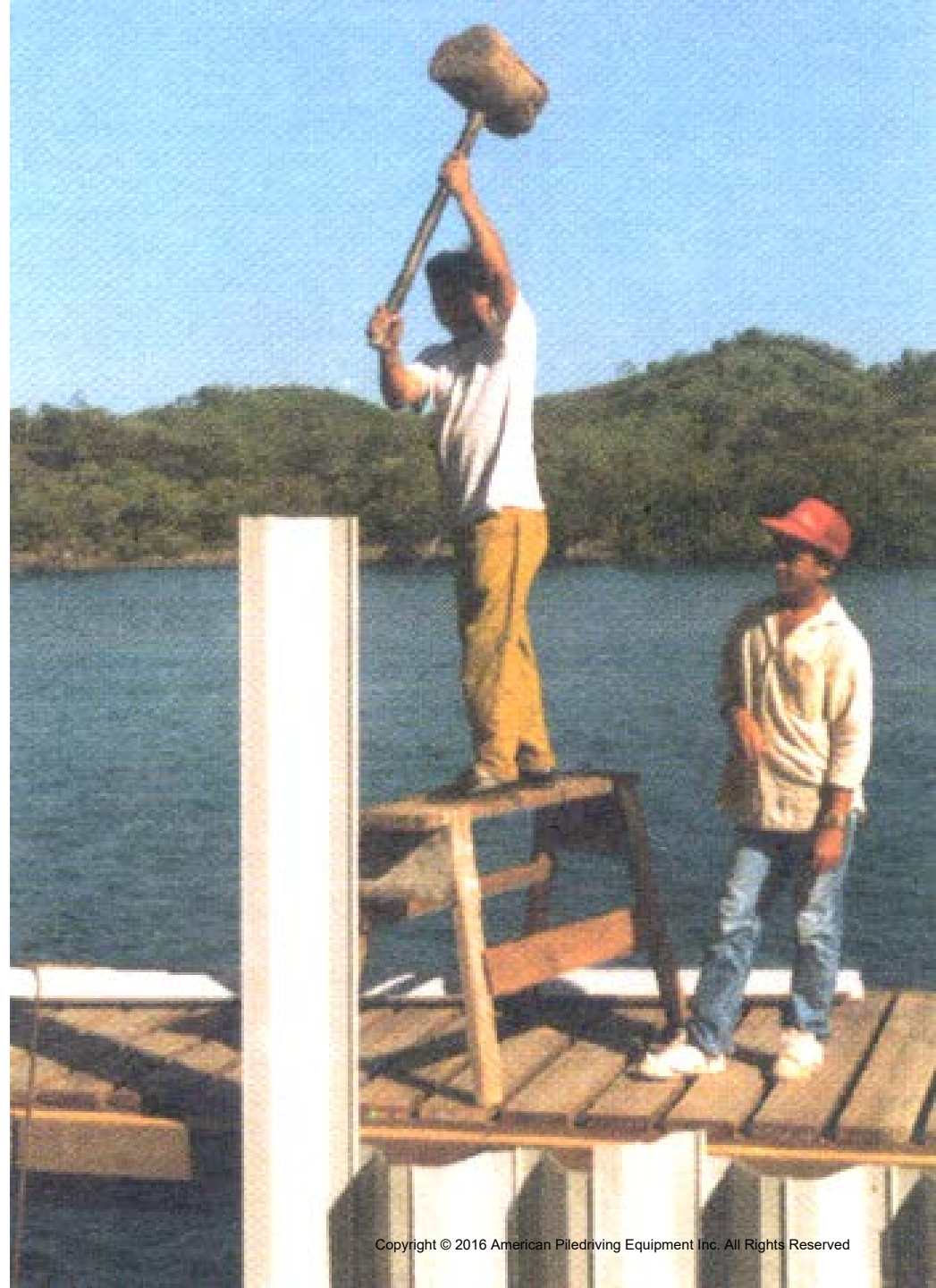

Man Powered Drop Hammers

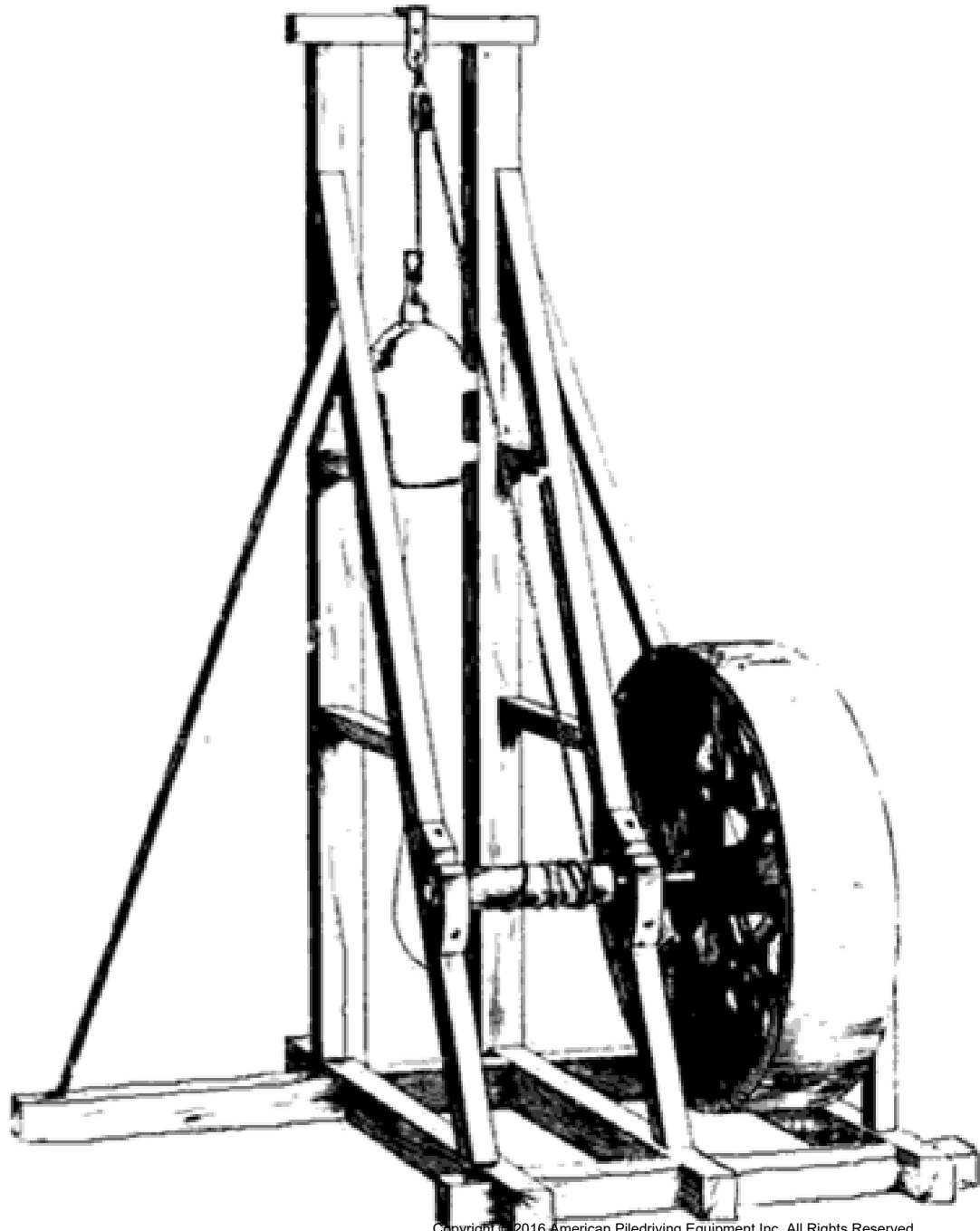

Machine Powered Drop Hammers



On Shore Air Hammers





Air Steam Hammers



Off Shore Steam or Air Hammer

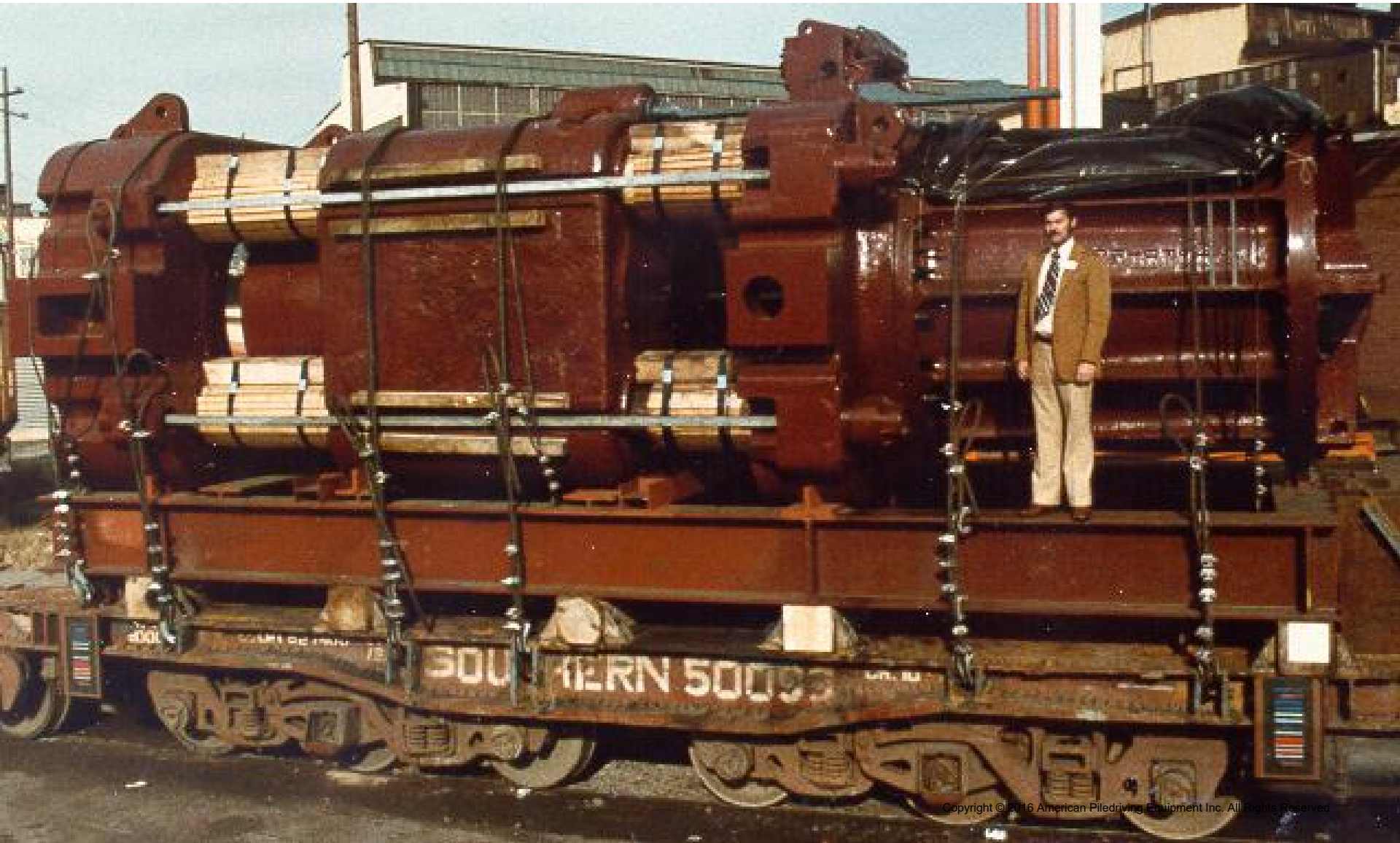

Diesel Hammers





Delmag's D200

Hydraulic Impact Hammers



Hydraulic Impact Hammers



Hydraulic Impact Hammers



Hydraulic Impact Hammers

Menck



IHC

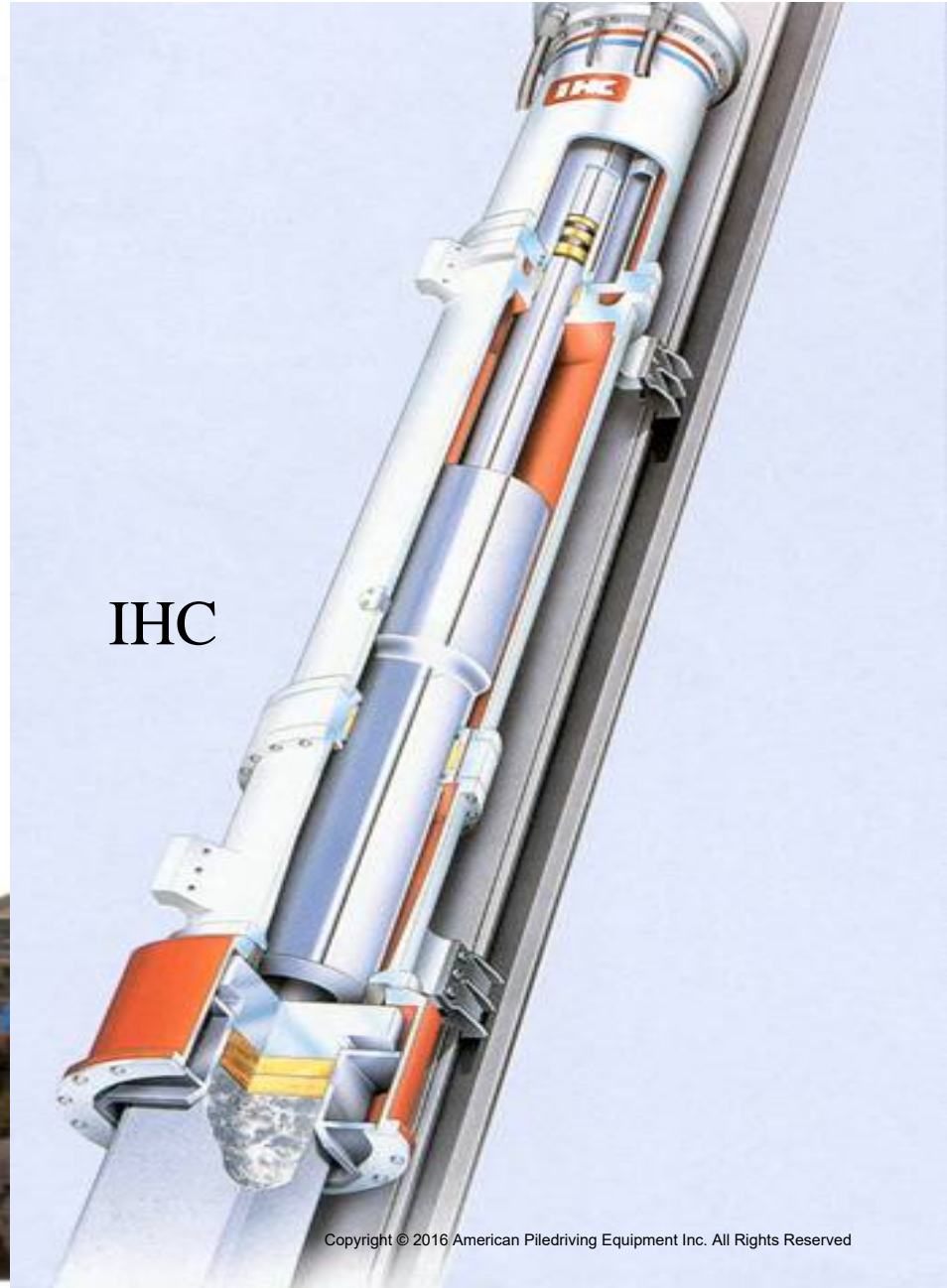

Junttan Hydraulic Impact Hammer



Low Headroom Hydraulic









Vibratory Pile Driver/Extractors

Sonic Impact Hammers

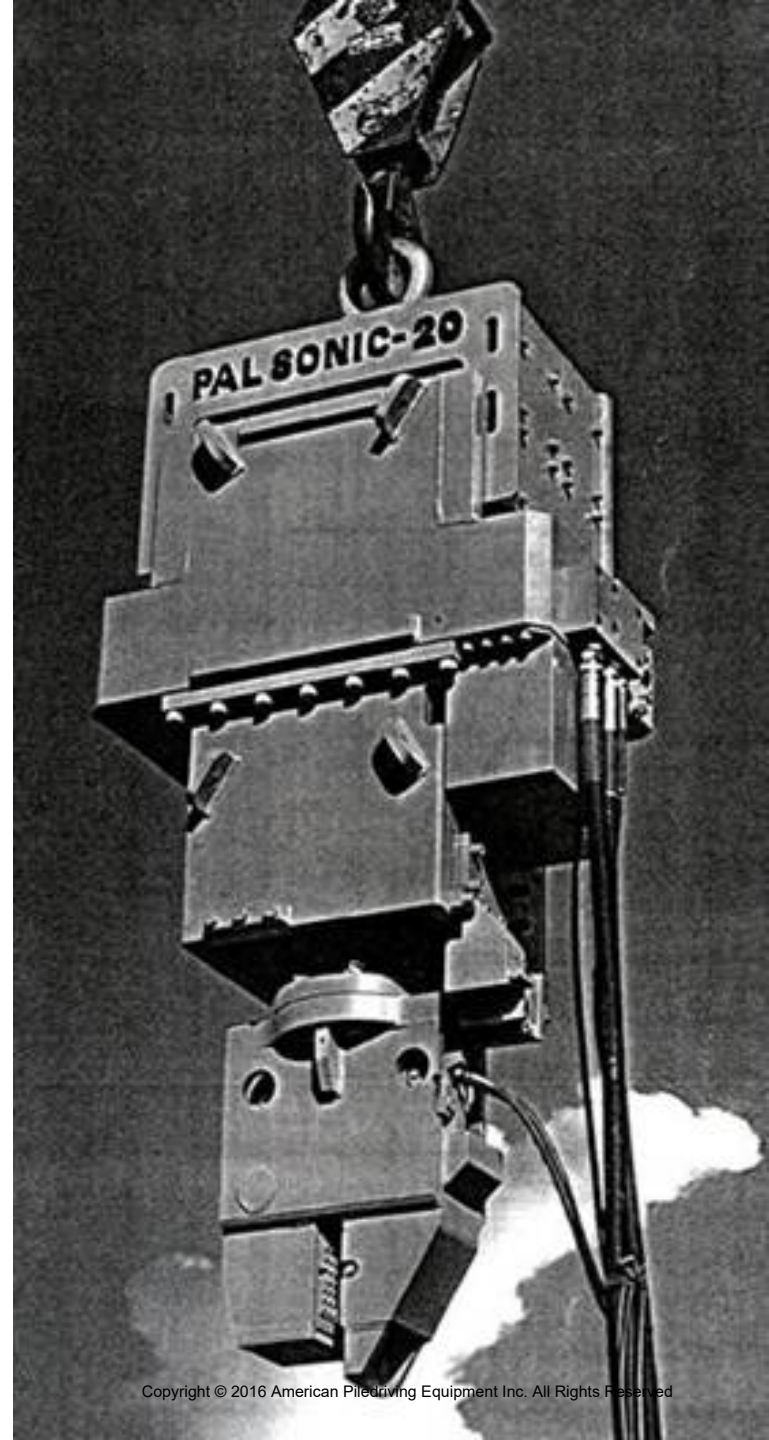



Simple Pile Driver

-

Driving Pile with Maul



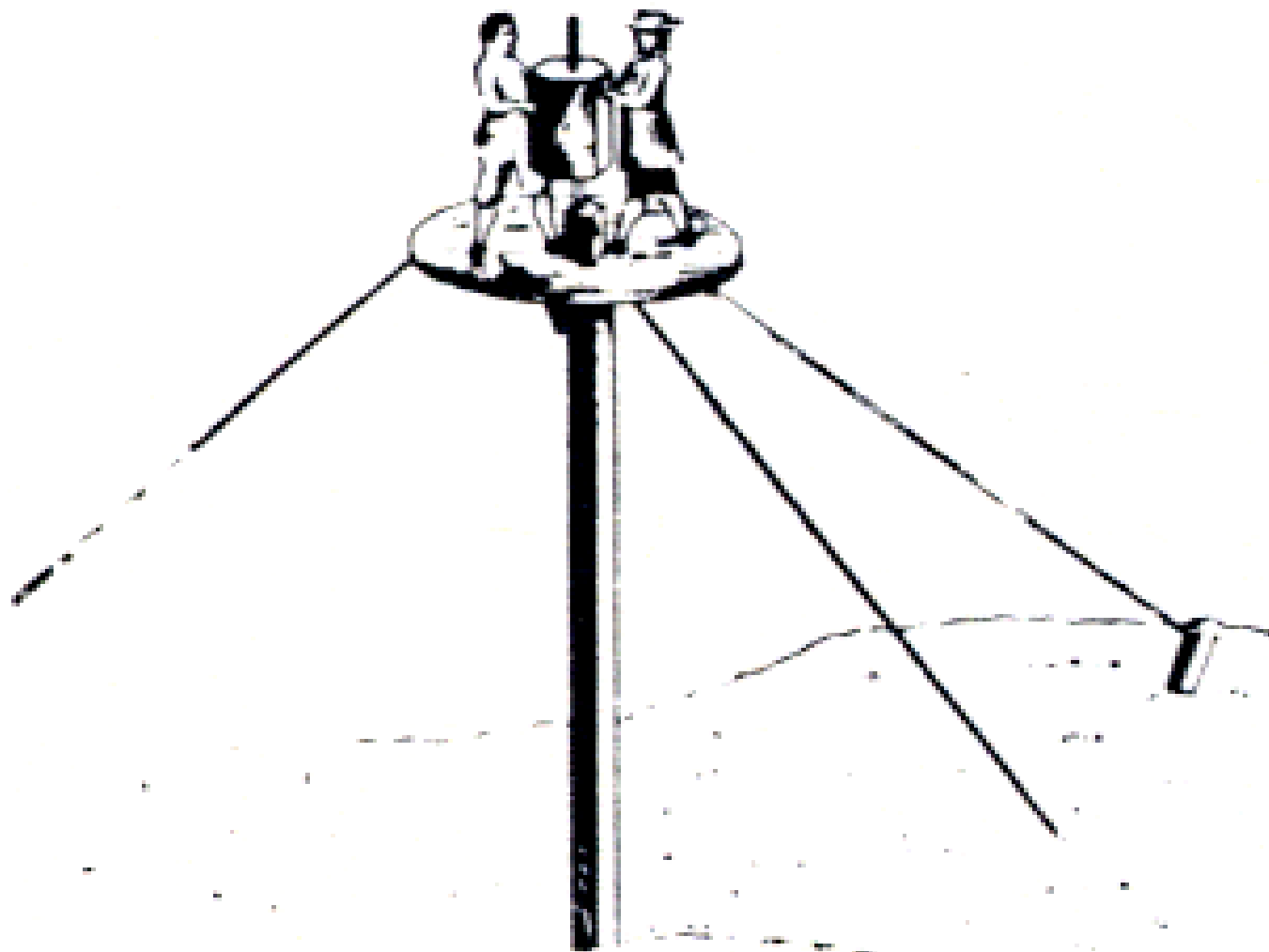

The Hand Ram

As piles became longer, thicker and thus heavier, the falling weight had to be increased in size.

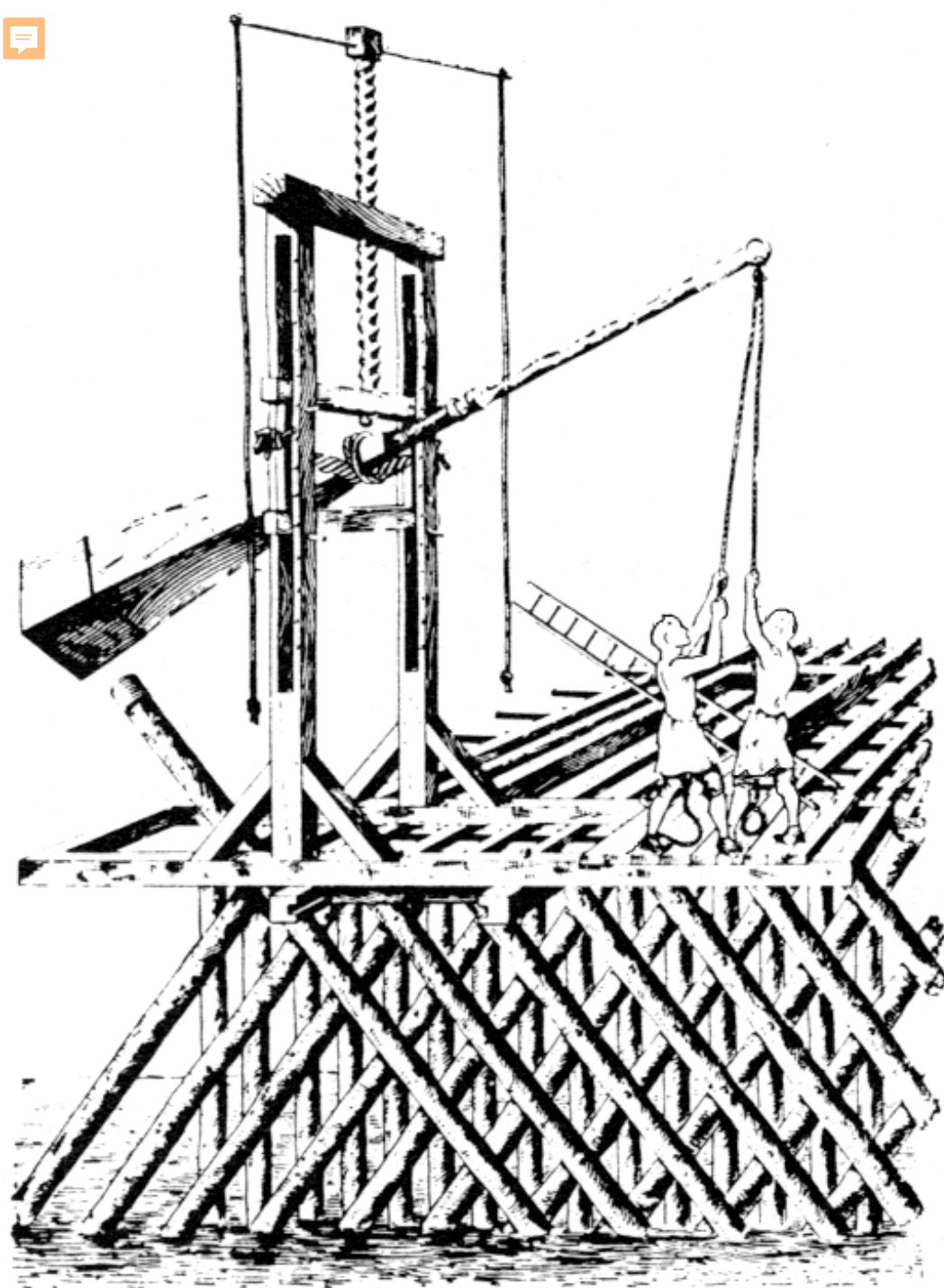

The hand operated machine maul.

As weight of the ram increased, more man power was required.



Introduction of pile driving leaders systems and other new components.

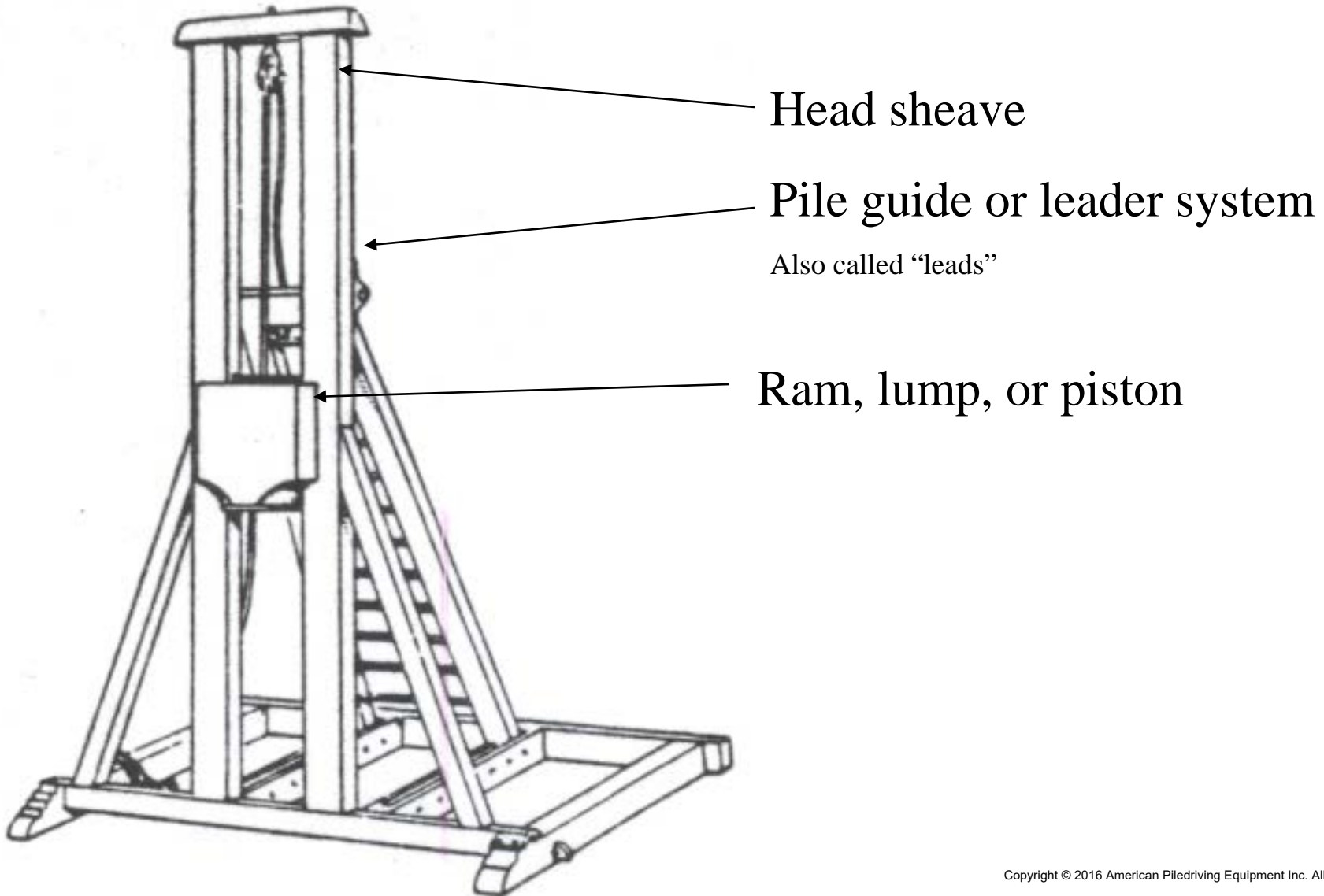

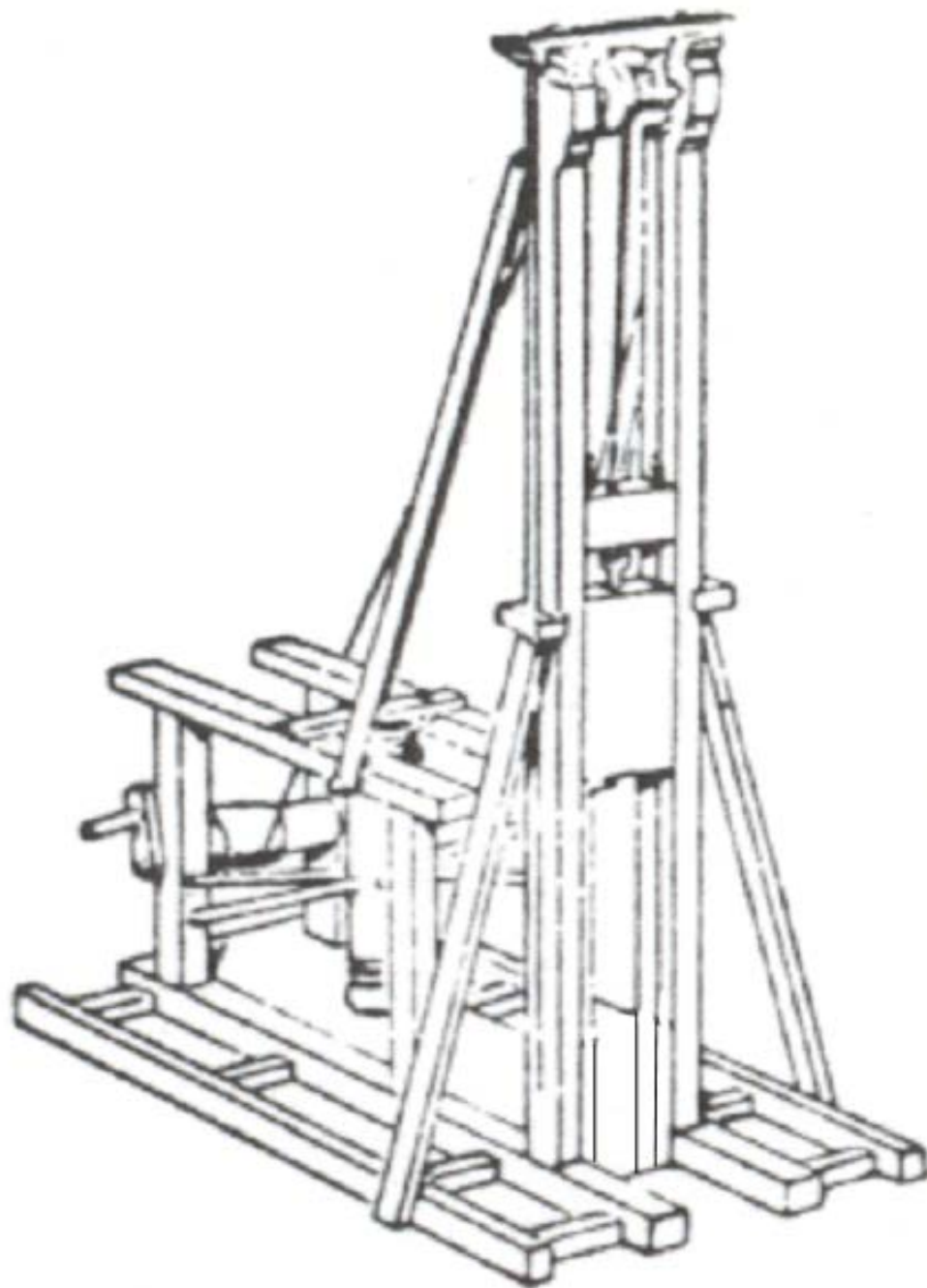

Tripping Device

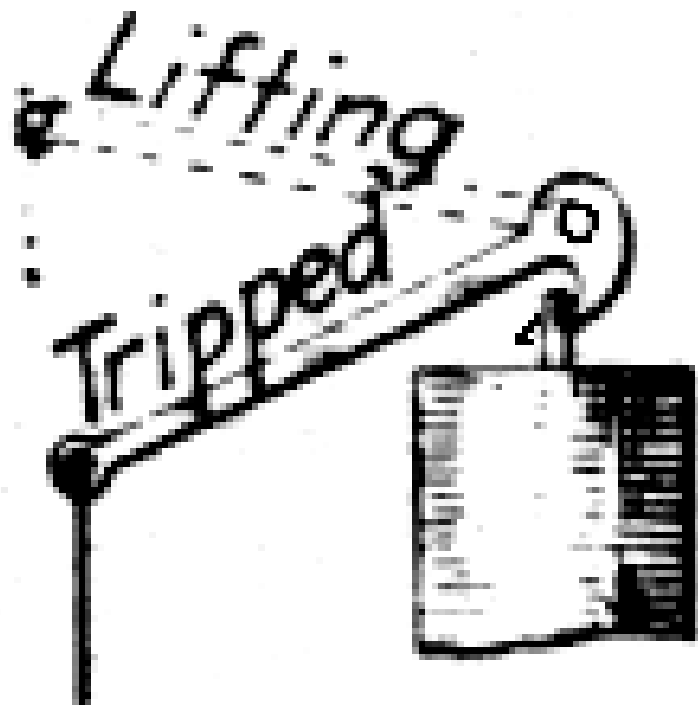

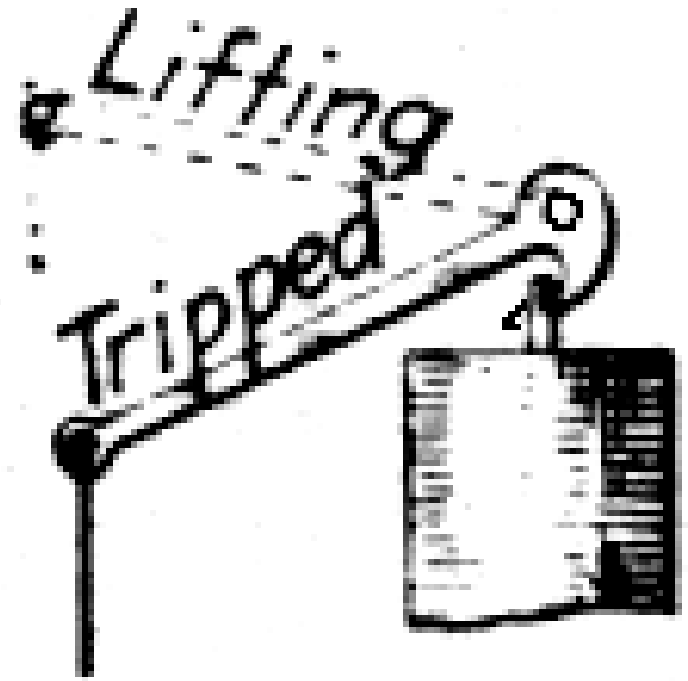
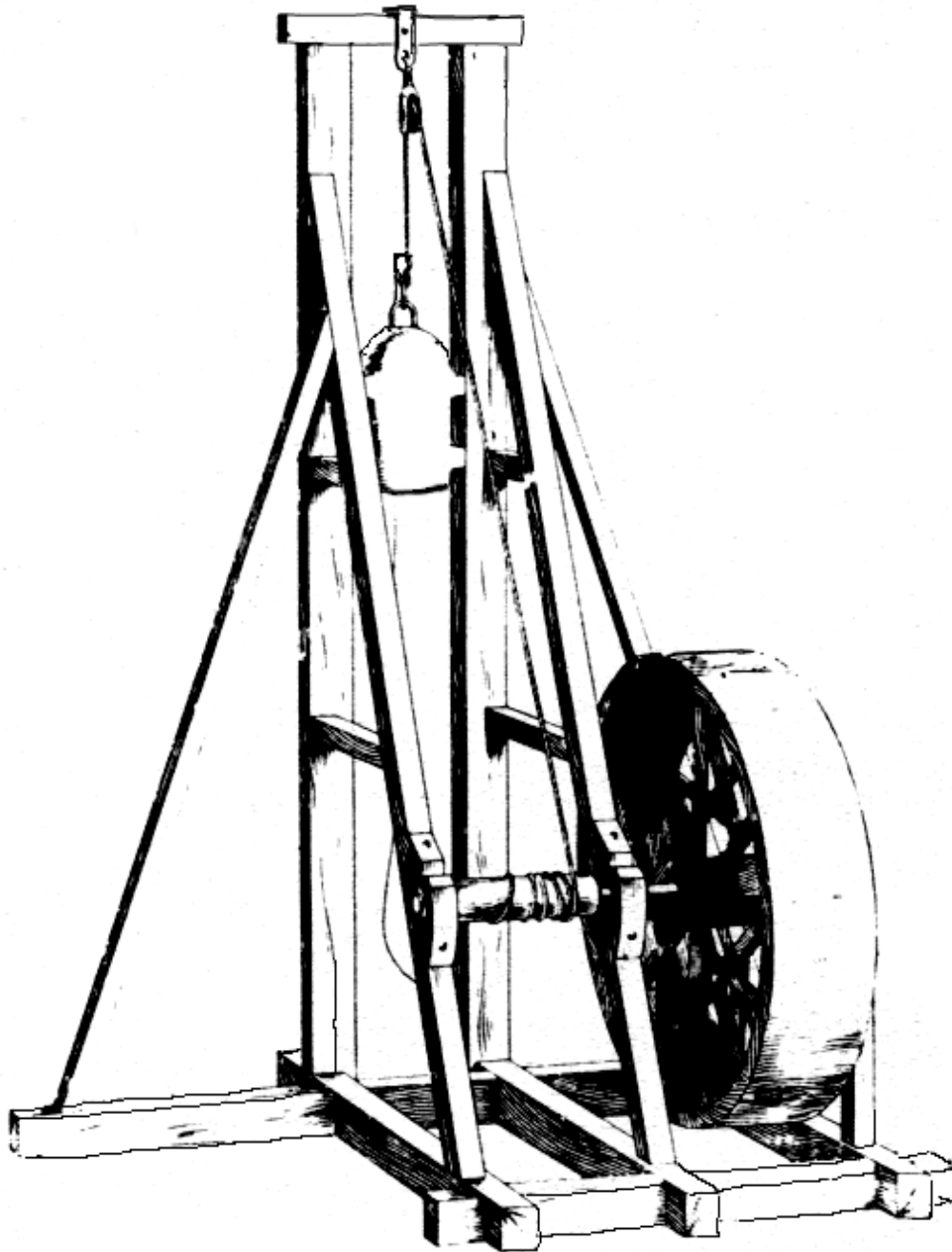

Simple trip system designed by the Romans.

Treadmill Driver with Rope Trip Release

Ancient Drop Hammers

REFERENCES

- A. The great Shaft, on which are the great Wheel, and Drum.
 - B. The great Wheel, with Craps that forms the handle-head with a Rope, to prevent the Ram from falling up, when the Ram is discharged.
 - C. The Drum, on which the great Rope is wound.
 - D. The Follower, with a Roller at one Corner, in which is crooked a Spring, that take hold of the Ram, & are fasten'd to the other End of the great Rope, as they pass over a Pulley, near the upper end of the Guide, between which the Ram falls.
 - E. The inclined Planes, which serve to open the Craps, and discharge the Ram.
 - F. The spiral Barrel, that is fast'nd to the Drum, on which is wound a Rope, with a counter, as with a wheel the Follower, from ascending, when it falls down to catch up the Ram.
 - G. The great Bolt, which locks the Drum to the great Wheel.
 - H. The small Lever, which has a Weight fix'd at one End, passes through the great Shaft, when the great Wheel, & always tends to push the great Bolt upwards, & lock the Drum to the great Wheel.
 - I. The spring Lever, which passes through the hollow axis of the great Shaft, between upon a small Cover, & has near the upper End a Catch, by which the crooked Lever keeps it down.
 - K. The great Lever, which presses down the forcing Barr, & discharges the great Bolt, at the time the long End is tyed up by the Follower.
 - L. The crooked Lever, one End of which has a Roller, which is kept open by the great Rope, the other end being upon the Catch of the forcing Barr, during the time the Follower is descending.
 - M. The Spring that presses against the crooked Lever, & discharges it from the Catch of the forcing Barr, as soon as the great Rope slackens, & gives liberty to the small Lever to push up the Bolt.
- By the Ram being round, the great Rope is wound about the Drum, & the Ram is drawn up all the Springs come between the inclined Planes, where they are oppos'd, & the Ram is discharged.
- Immediately after the Ram is discharged, the Roller which is at one Corner of the Follower, takes hold of the Rope that is fasten'd to the long End of the great Lever, & lifts it up, so that the long End of the forcing Barr, unlocks the Drum, & the Follower runs down by its own Weight.
- As soon as the Follower touches the Ram, the great Rope slackens, & the Spring (M) discharges the crooked Lever from the Catch of the forcing Barr, and gives liberty to the small Lever, to push up the great Bolt, & to lock the Drum to the great Wheel, & the Ram is drawn up again as before.

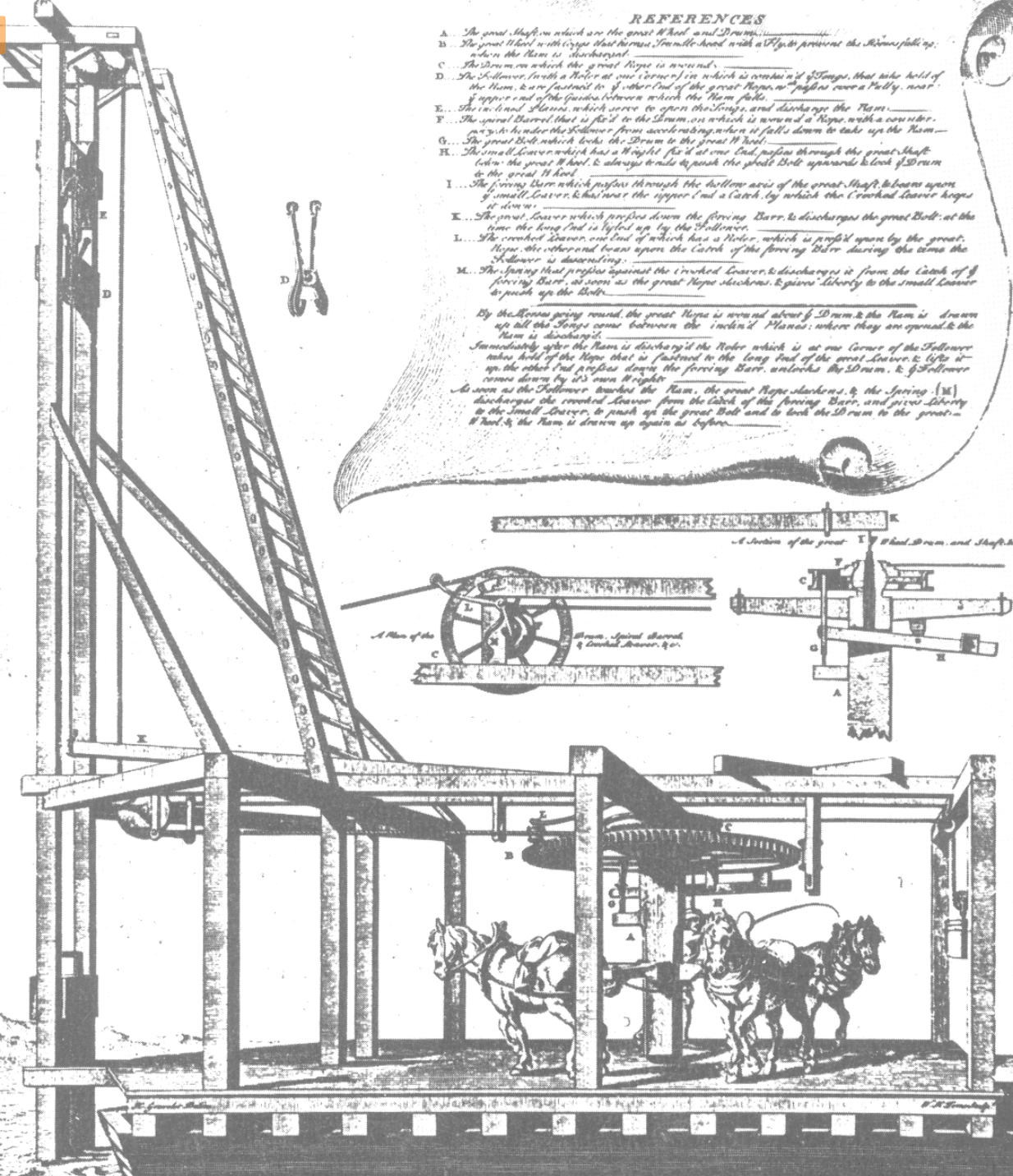

The drop hammer is a heavy weight lifted and dropped on the pile. It operates in guides that position the impact. In the past (and still occasionally) the weight is lifted by man or horse power. Now a line on a crane or a winch raises the weight to a predetermined height where a trip releases it to fall freely on the pile.

The weight of the ram is not less than one third the weight of the pile. A suitable cap with cushion material is used on the pile to distribute driving forces. Drop hammers are still commonly used in some parts of the world.

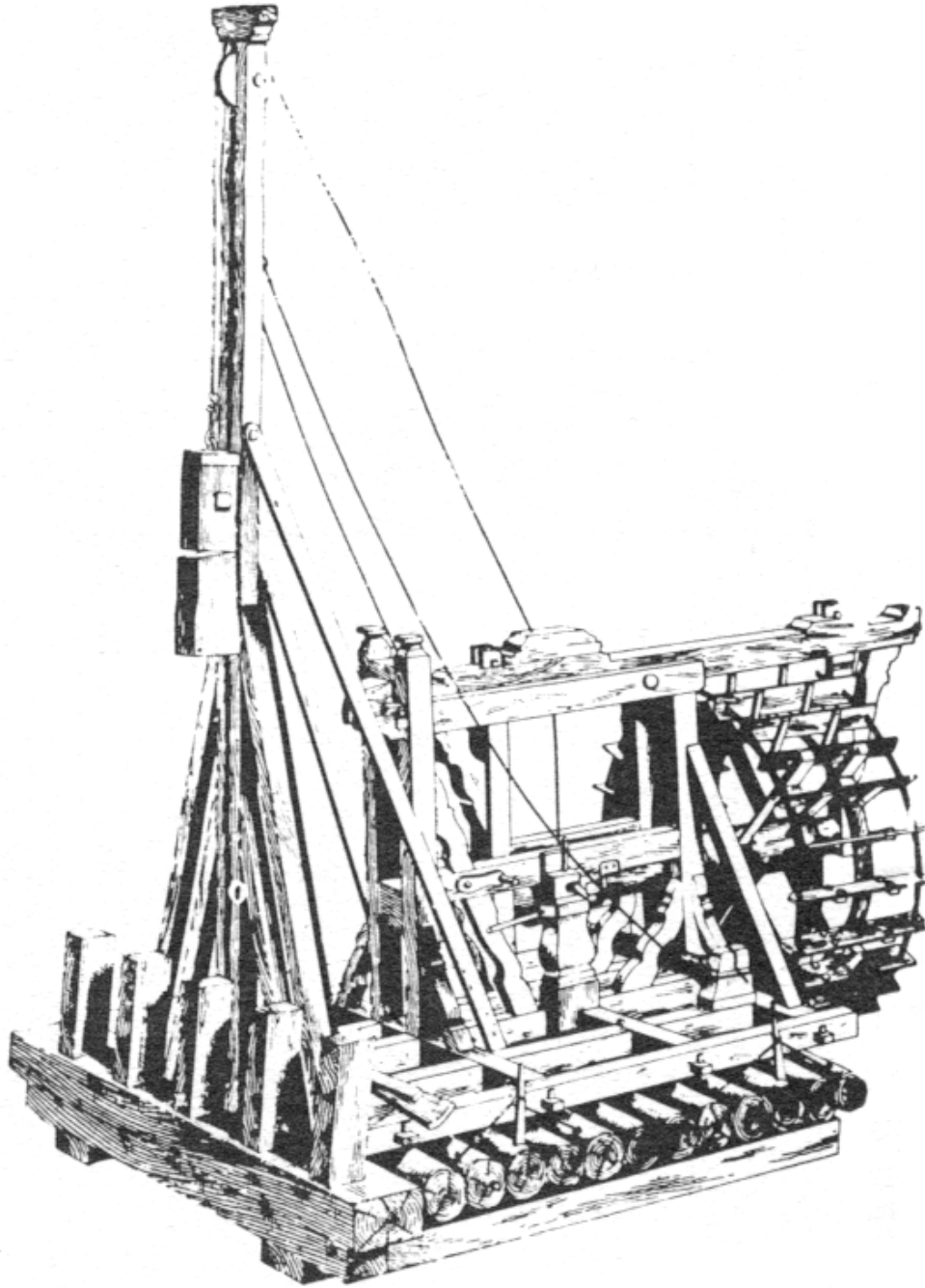

River Current Wheel Pile Driver With Slotted Single Lead

Paddles drive the
mechanism to lift the
ram.

Drop Hammer Sizes.

Standard drop hammers weigh from 500 to 3,000 lbs. In round number hundred weights.

50,000 lb Vulcan drop hammer.

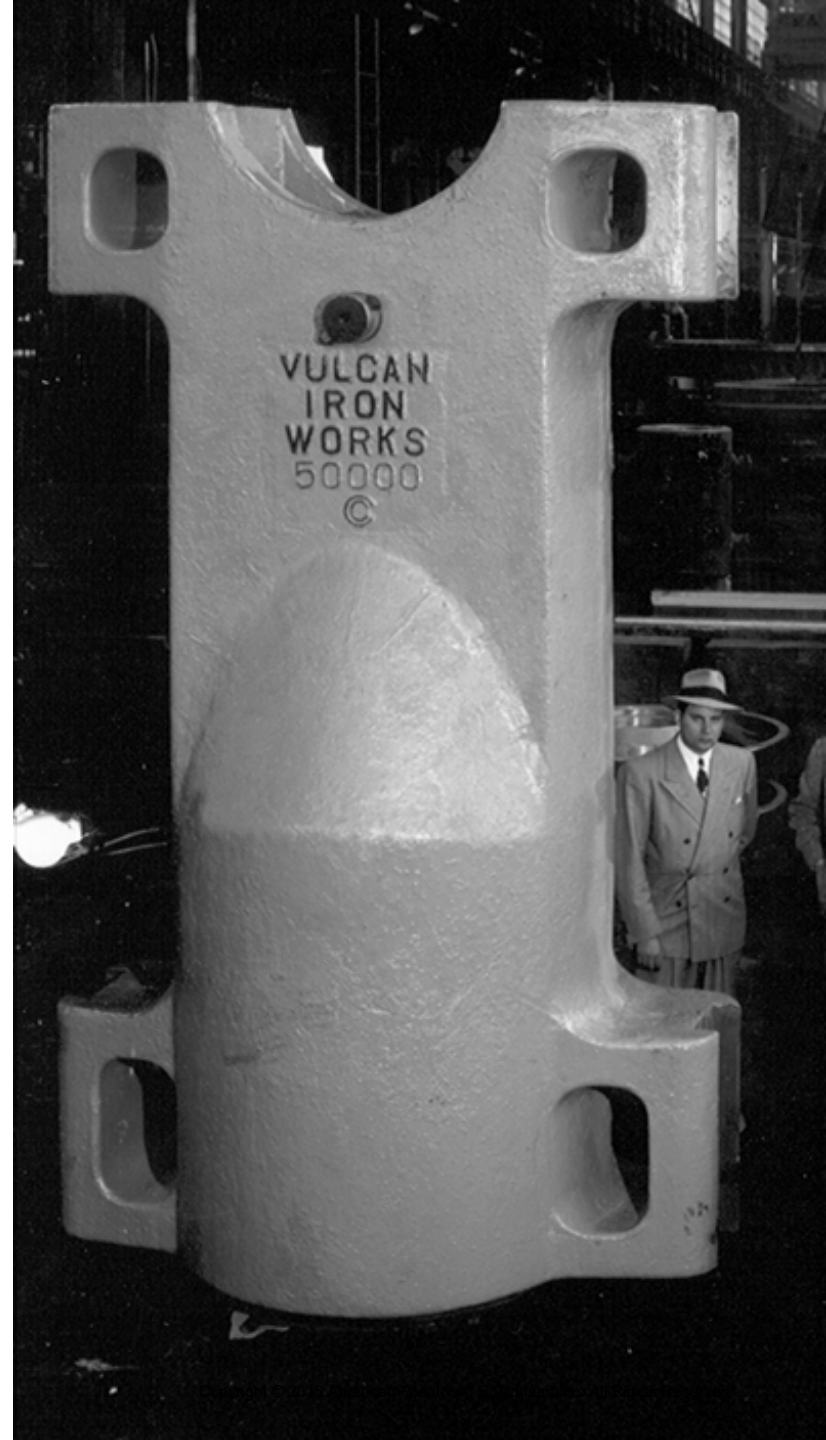

The available impact energy delivered per blow by a drop hammer is calculated simply by multiplying the weight of the hammer times its height of fall.

$$\text{Weight} \times \text{Height} = \text{Energy}$$



Impact energy delivered per blow by a drop hammer is calculated simply by multiplying the weight of the hammer times its height of fall.

Simple equation:

$$3,000 \quad \times \quad 2 \text{ feet} = \quad 6,000 \text{ ft. lbs.}$$

(ram weight) x (height) = Energy in Foot pounds

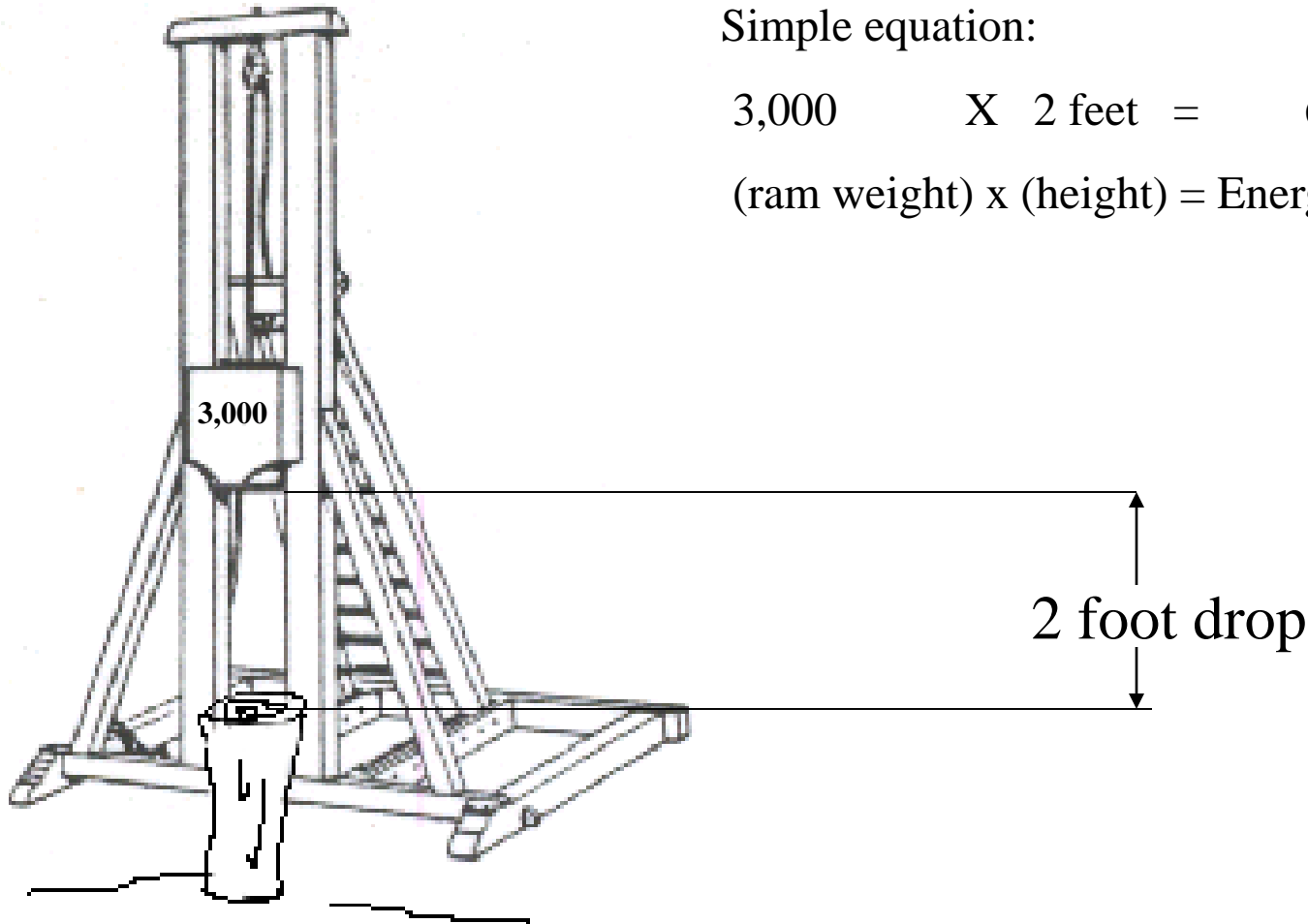

The higher the drop height, the greater the energy

A drop hammer
weighing 3,000 lb.
falling from
20-feet with
no bounce at
impact would deliver
60,000 ft-lbs of energy.

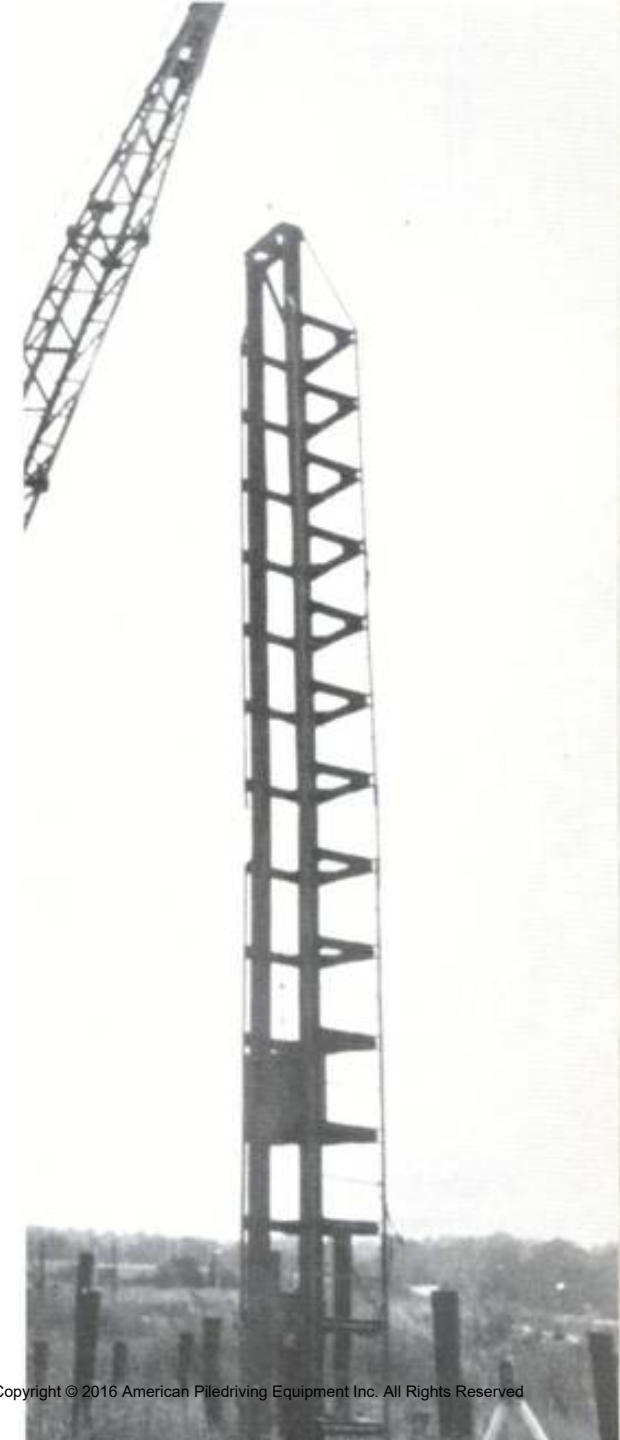

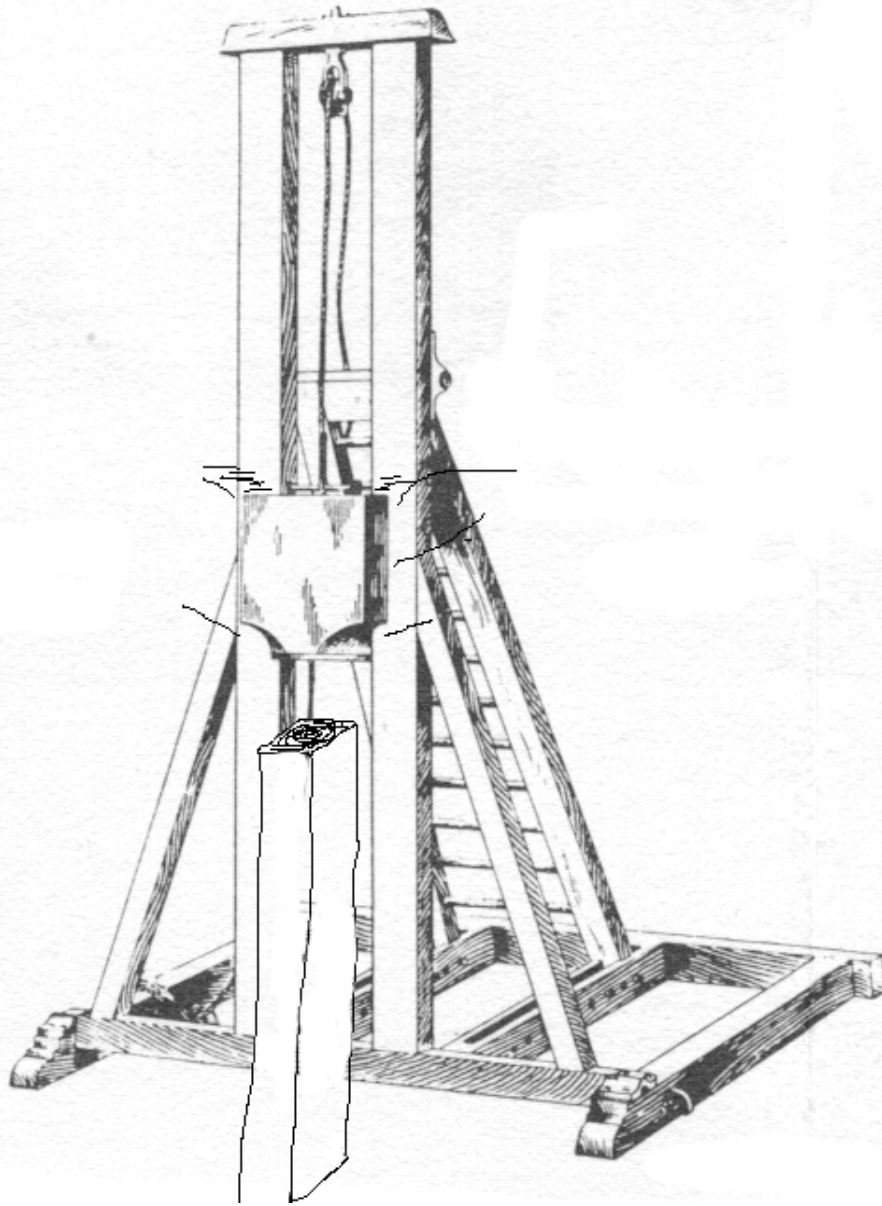

Re-bound Deduction

Whenever, upon striking the pile cap, the drop hammer bounces, twice the height of the bounce is deducted from the total height of fall to determine the net fall with which to calculate the delivered energy.

Deduct twice the bounce of the ram from the total drop height to determine net fall.



Energy Transfer
at impact.
Dropping from
too high will
damage pile.

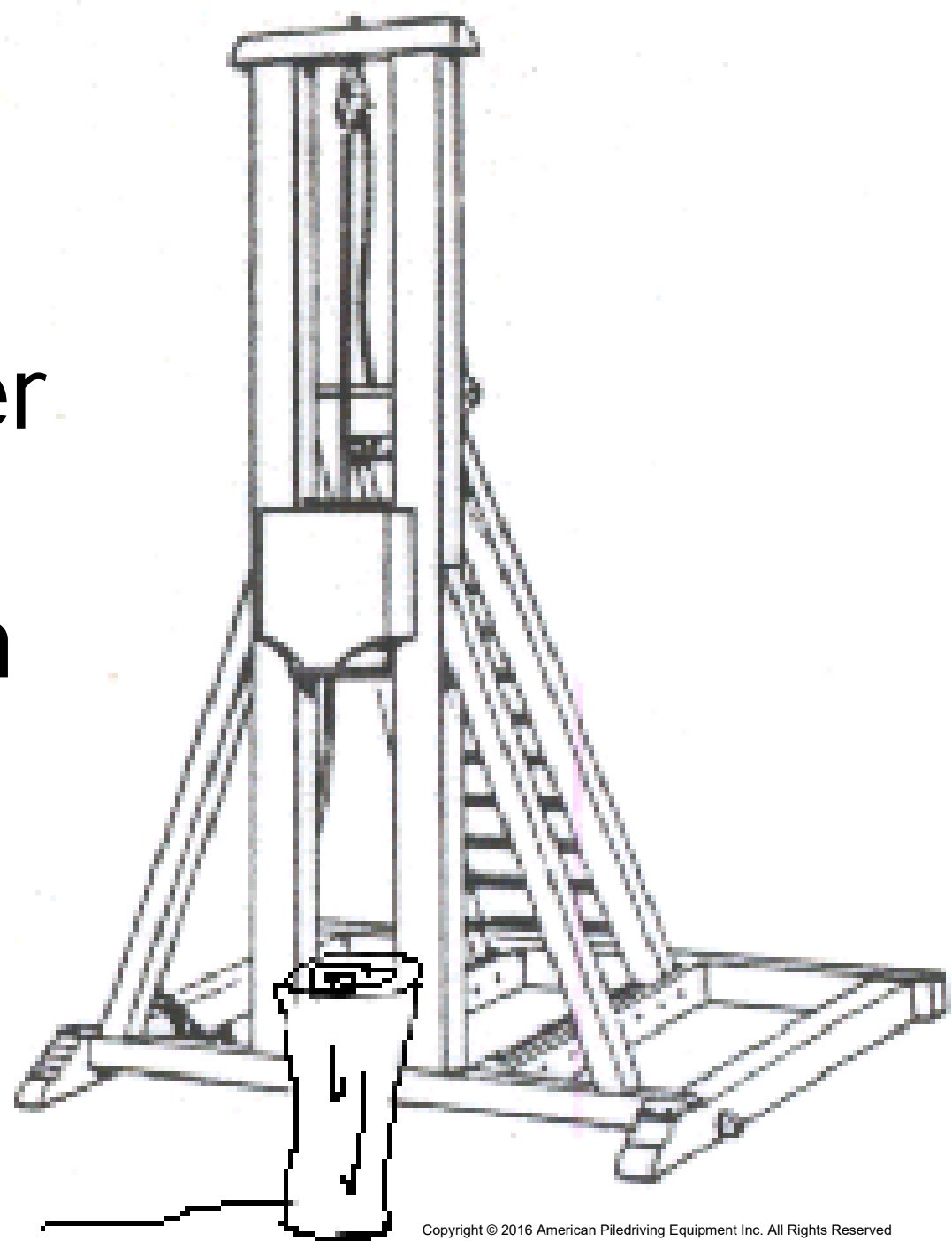



The introduction of the drive cap.

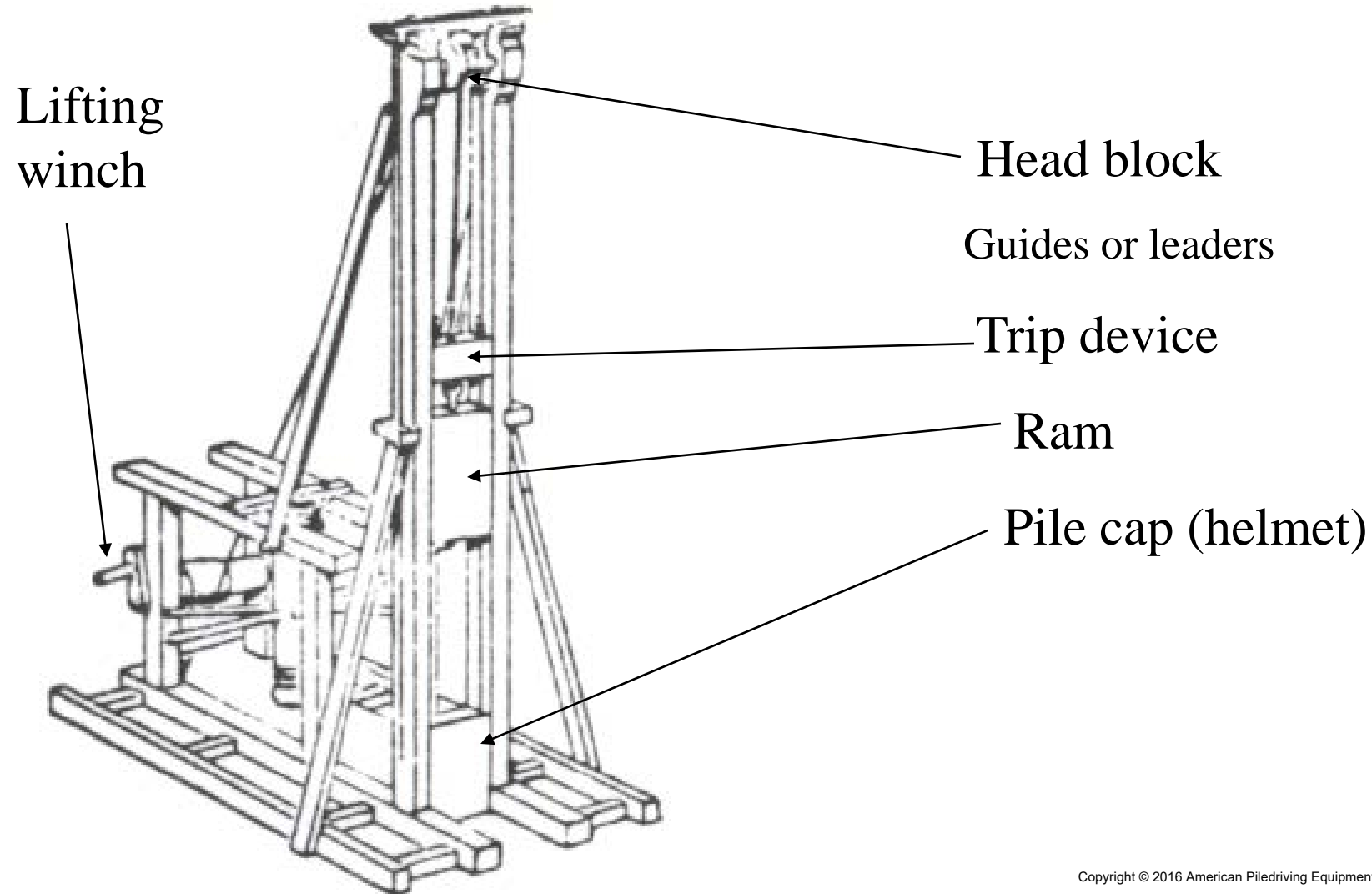

Pile cap or Drive cap

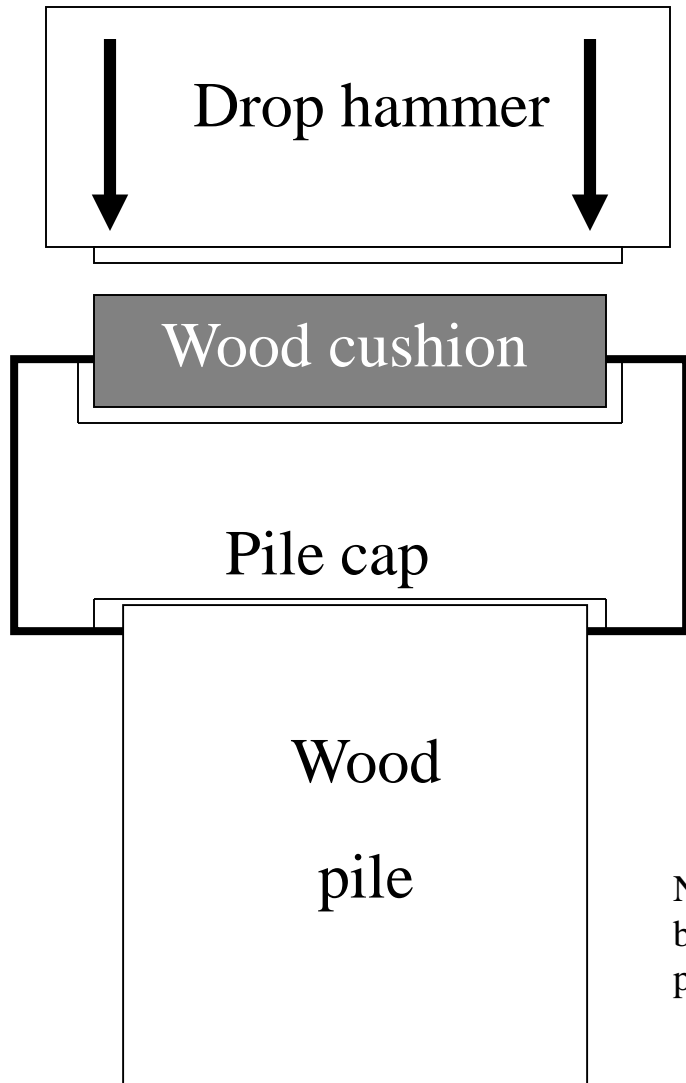

The cushion-pile cap combination serves as a “shock absorber”, blunting the sharp force loading on the pile at impact.

Note: concrete piles, which came much later in time, are protected by an additional wood cushion sandwiched between the top of the pile and the cap.



A closer look at a drop hammer drive cap

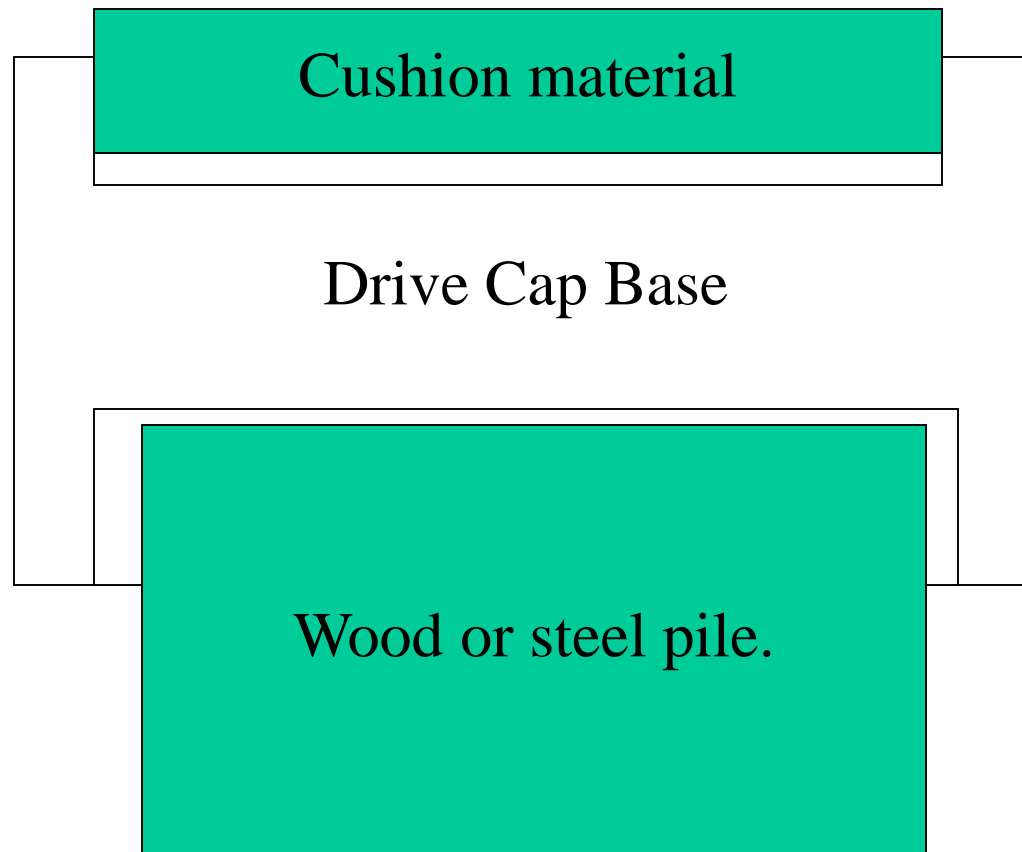

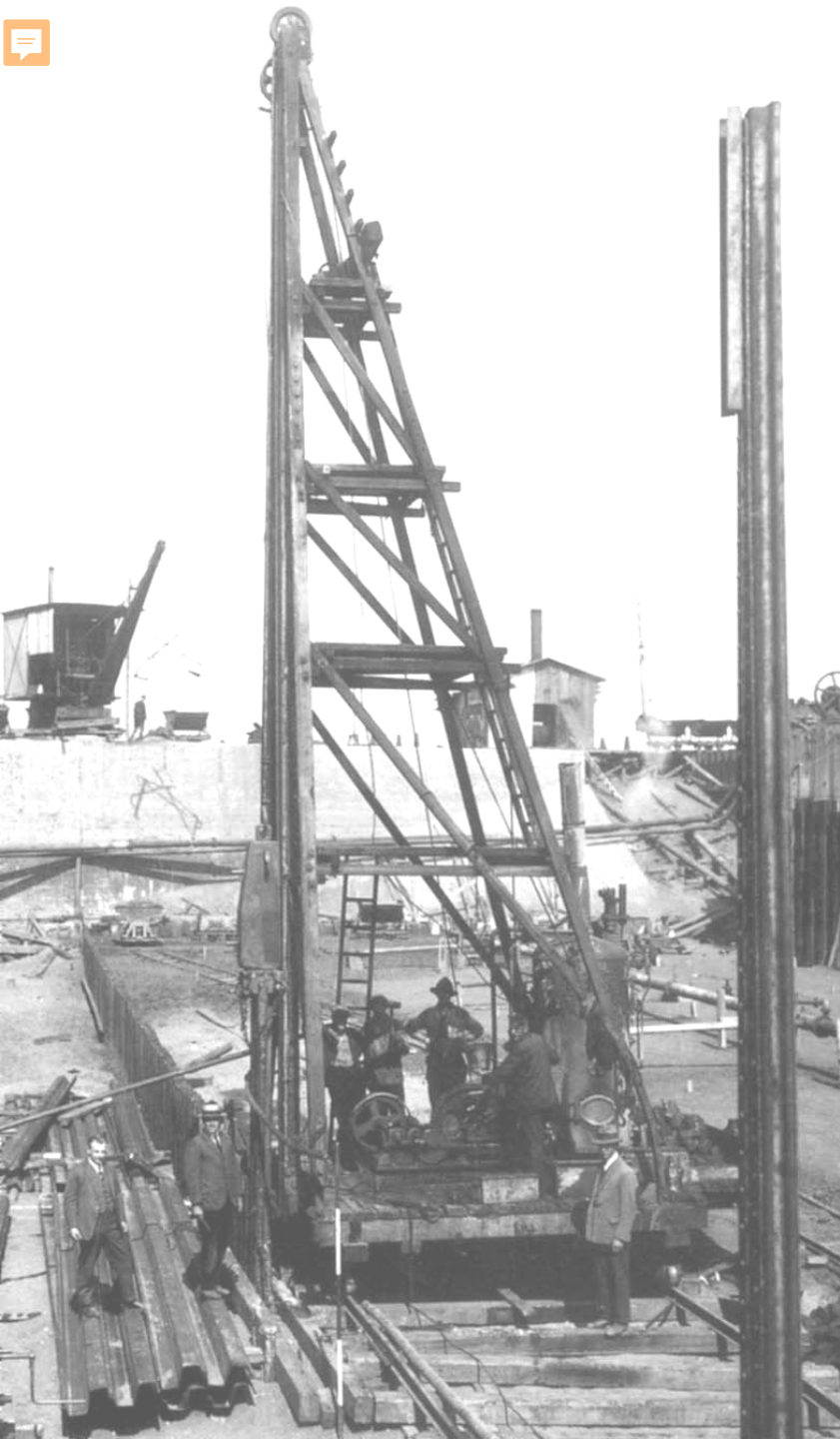

Drop hammers are still used today.
They are rudimentary pile drivers
with elementary maintenance.



Drop hammer riding in front
of leads driving concrete
spun piles.





Drop Hammers – Pros and Cons

Pro points

- Low cost investment
- Reliable
- Lightweight

Cons points

- Cannot drop more than 8 feet
- Slow production (4 to 10 blows per min.)
- Not accepted by many engineers due to inconsistent stroke and energy delivery.

Drive Cap Base



DCB Drive Cap Base 8 by 26 inch
Weight without stricker plate or cushion: 1200 lbs.

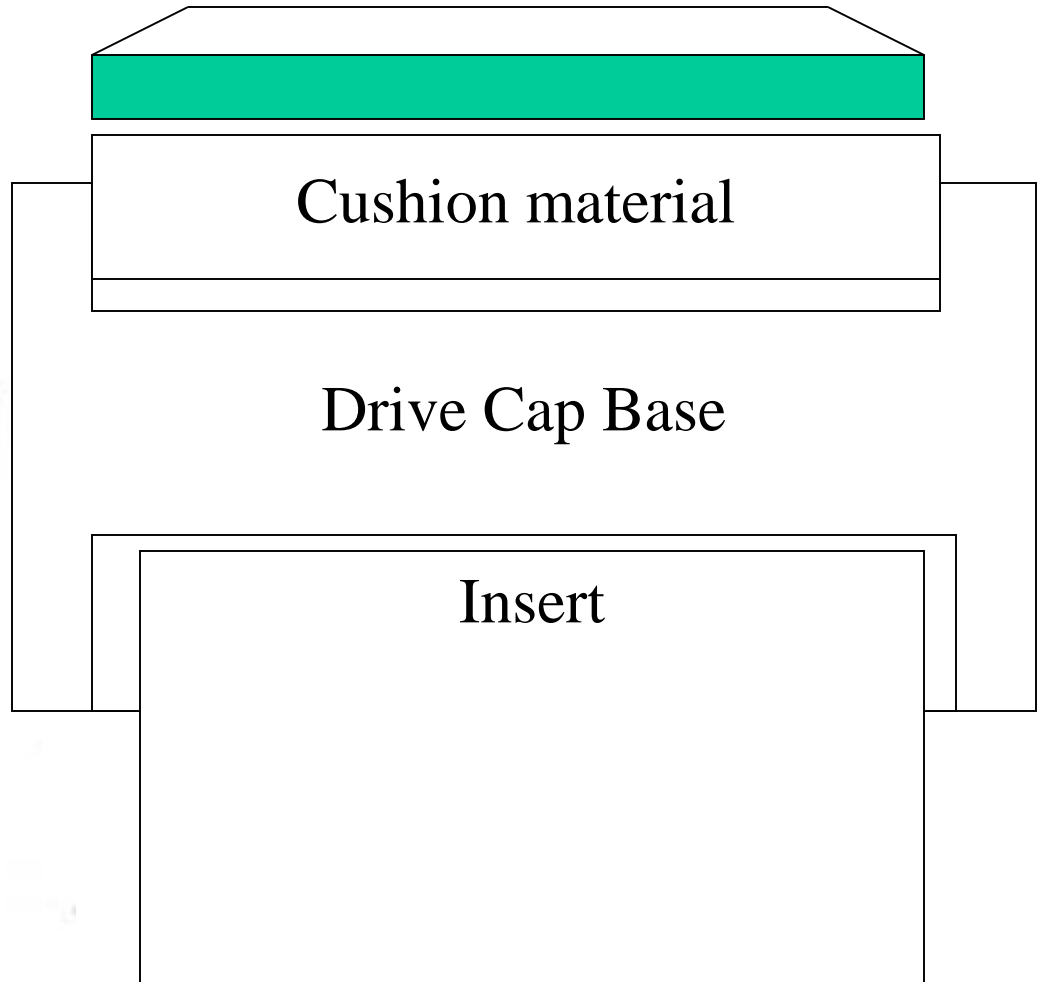



Striker plate



Hammer Cushion- Aluminum



**Aluminum cushion material
1/2 thick plates in various diameters**

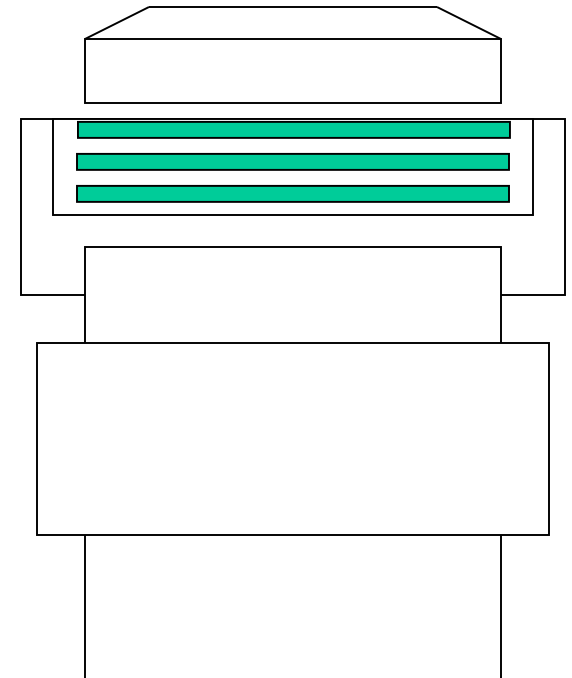

Hammer Cushion



Cushion material, micarta or conbest

Cushion Material - Nylong



**Nylon cushion material
2 inch thick in various diameters
Use on D30 and smaller type hammers
Switch to aluminum and conbest on larger hammers**



Inserts

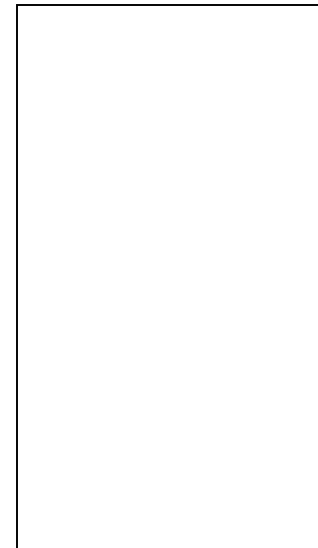
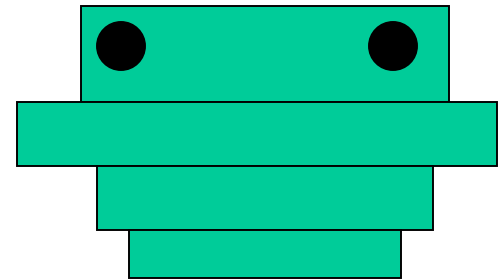

Sheet Pile Insert



Insert: Square box type

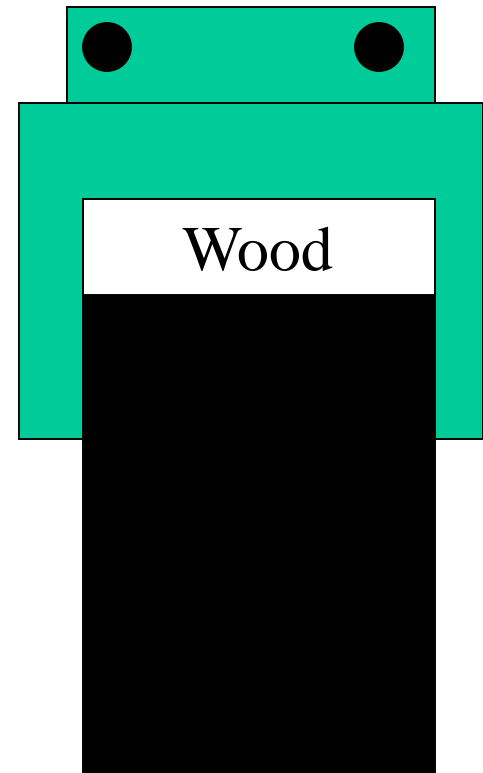

Insert for H-beam and small pipe





Drive Cap Layout (diesel hammer)

Diesel hammer

Rubber rebound ring

Anvil

Striker plate

Drive Cap base

Rigging of drive cap base to bottom of hammer

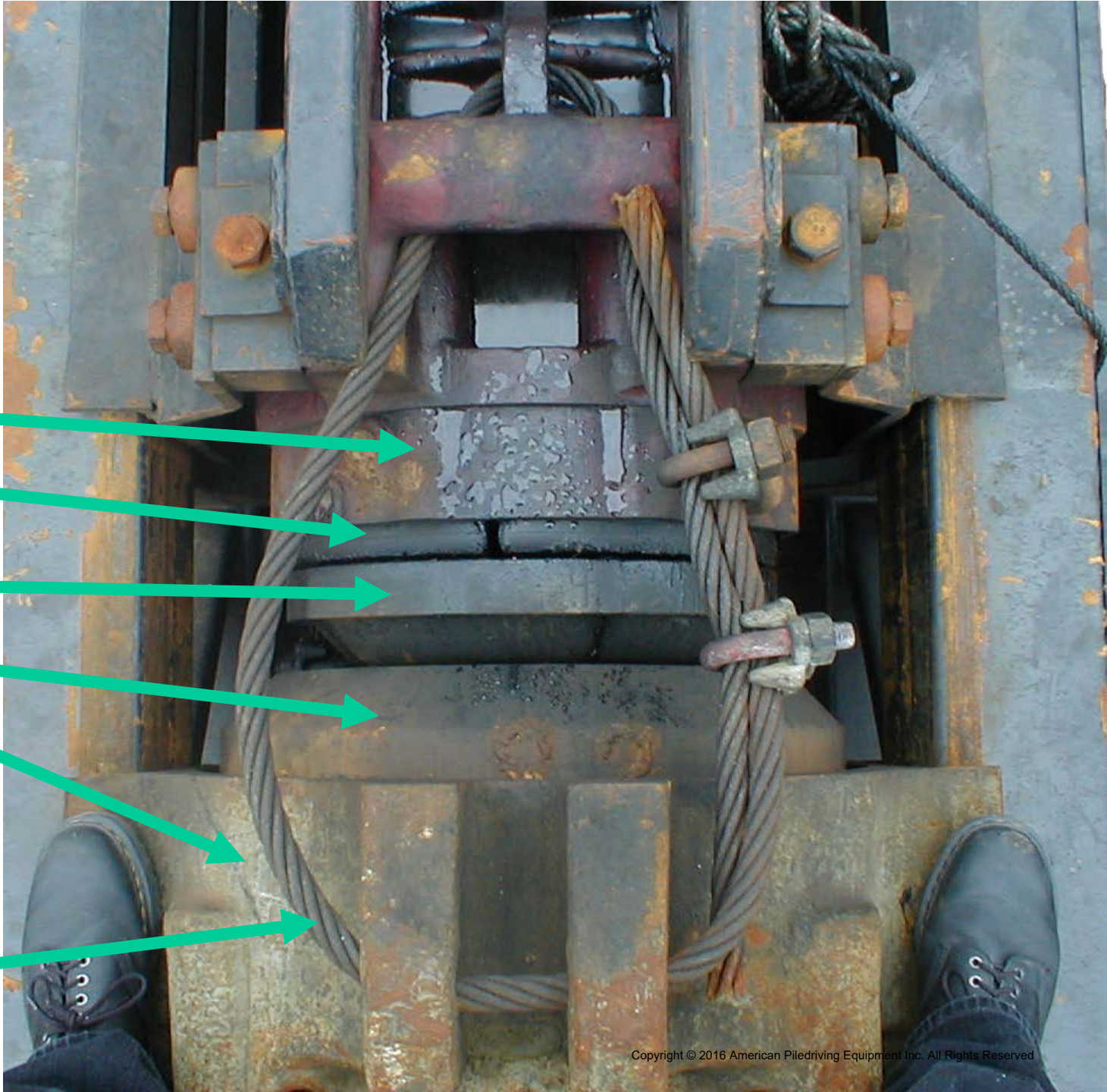

Standard drive cap layout

Note proper rigging of drive cap to hammer and pipe insert to drive cap.

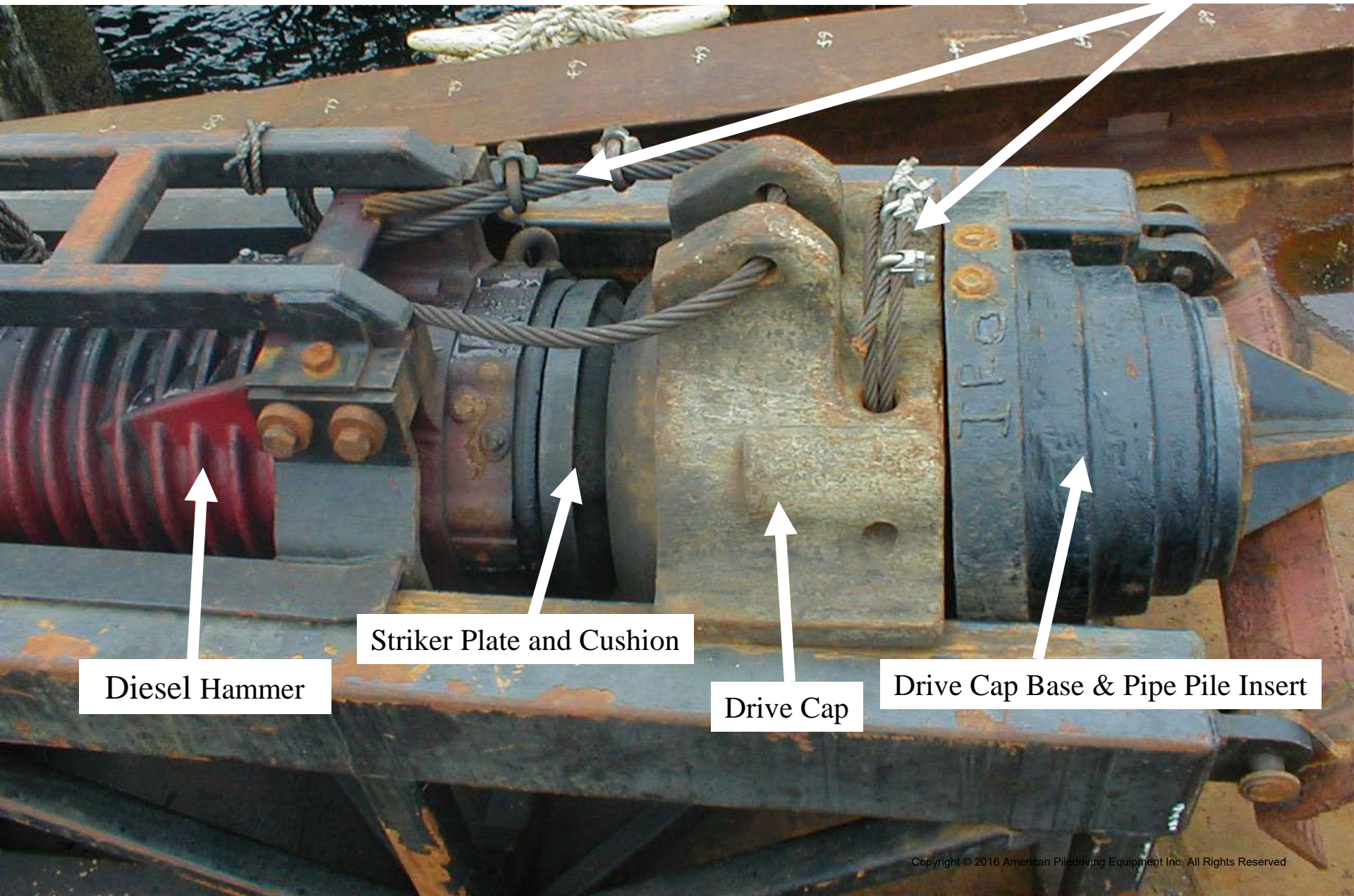

Diesel Hammer

Striker Plate and Cushion

Drive Cap

Drive Cap Base & Pipe Pile Insert

Common Pile Types

Wood piles (Uncoated and coated)

H-Beams

Steel sheet piles

Square Concrete Piles

Octagon Concrete piles

Concrete Pipe Piles

Concrete Sheet Piles

Steel Pipe Piles

King Piles

Power Pole Foundations

Mini Piles

Casings and Caissons

Plastic Sheet Piles

Composite Pipe Piles

Tarpon Piles

Conductor Piles

Monotubes

Wood Piles

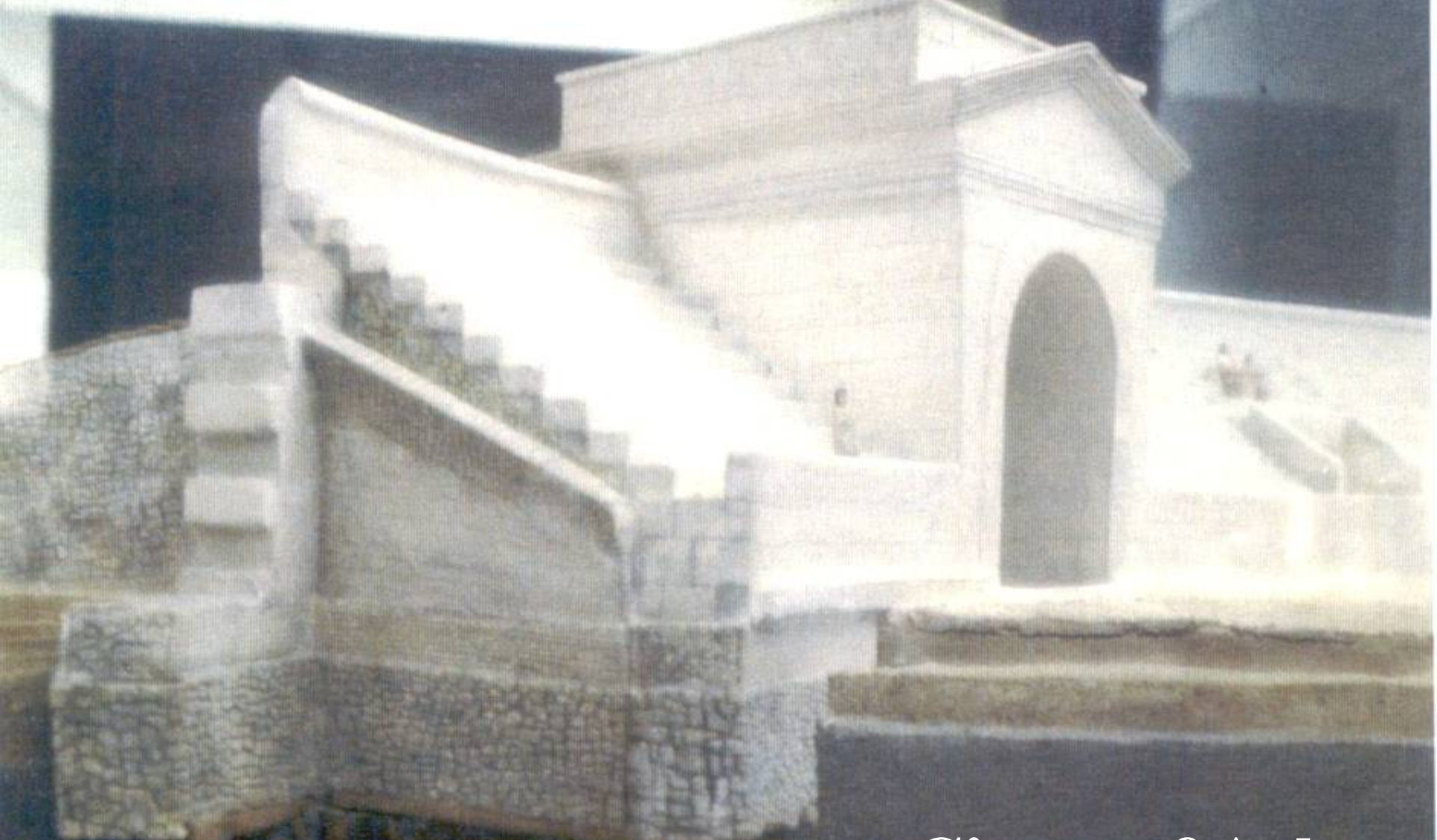

Circus of Arles 900 A.D.



Wood Piles driven
in 81 A.D. in Rome
for a horse race
track like that seen
in the Movie
Ben Hur

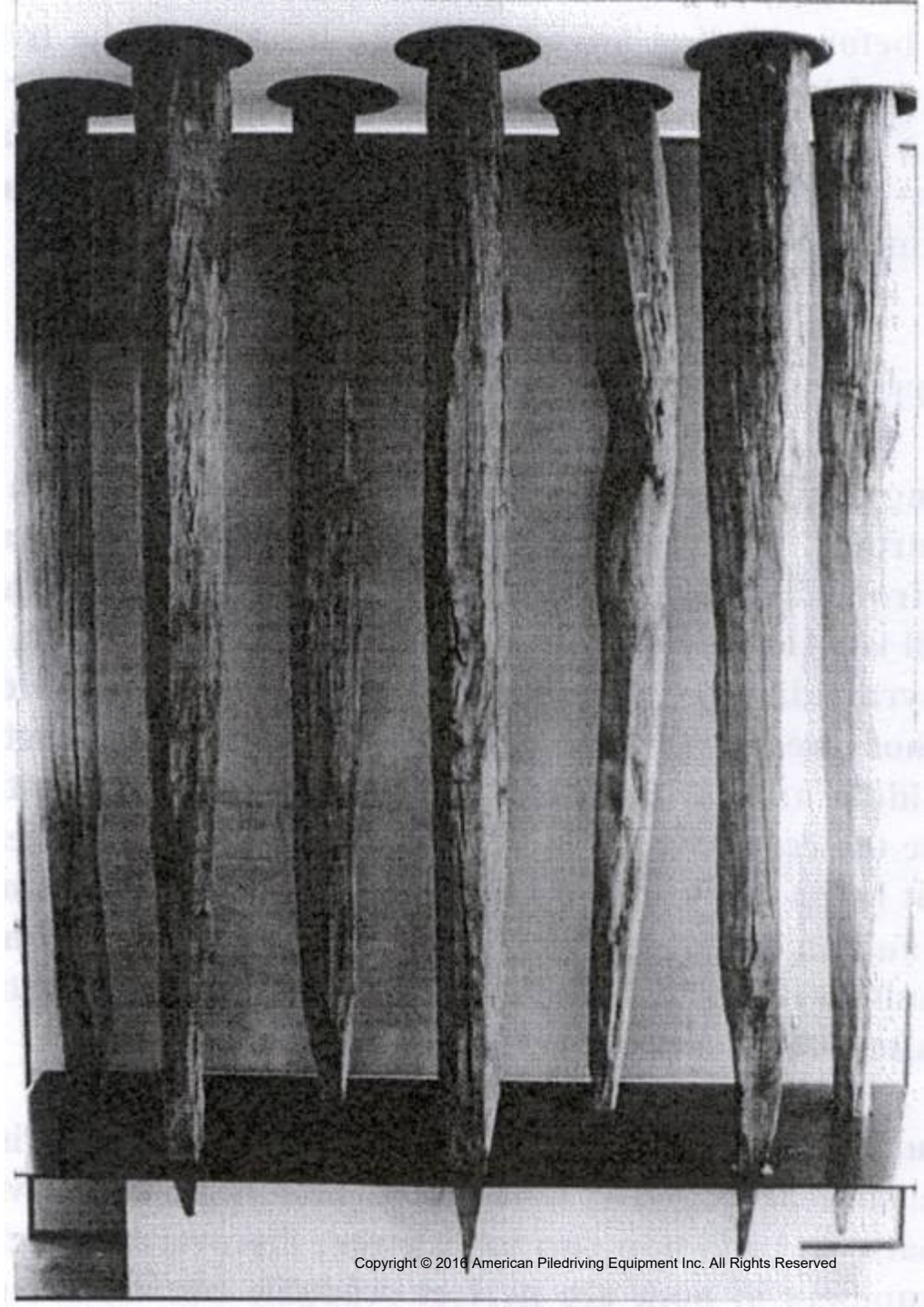

Wood piles
driven in 81
A.D.

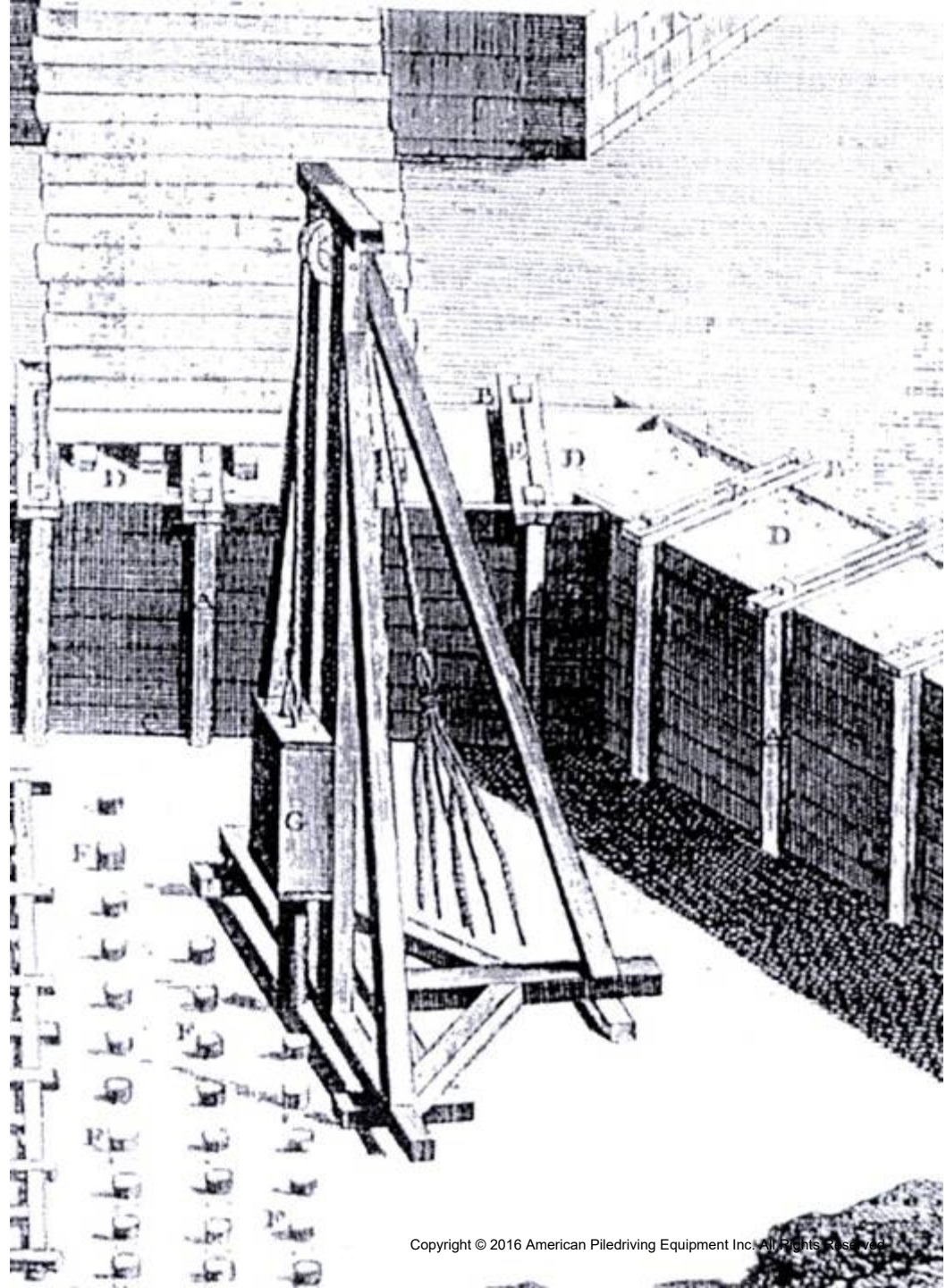

Cut away view of actual foundation of Roman built structure.

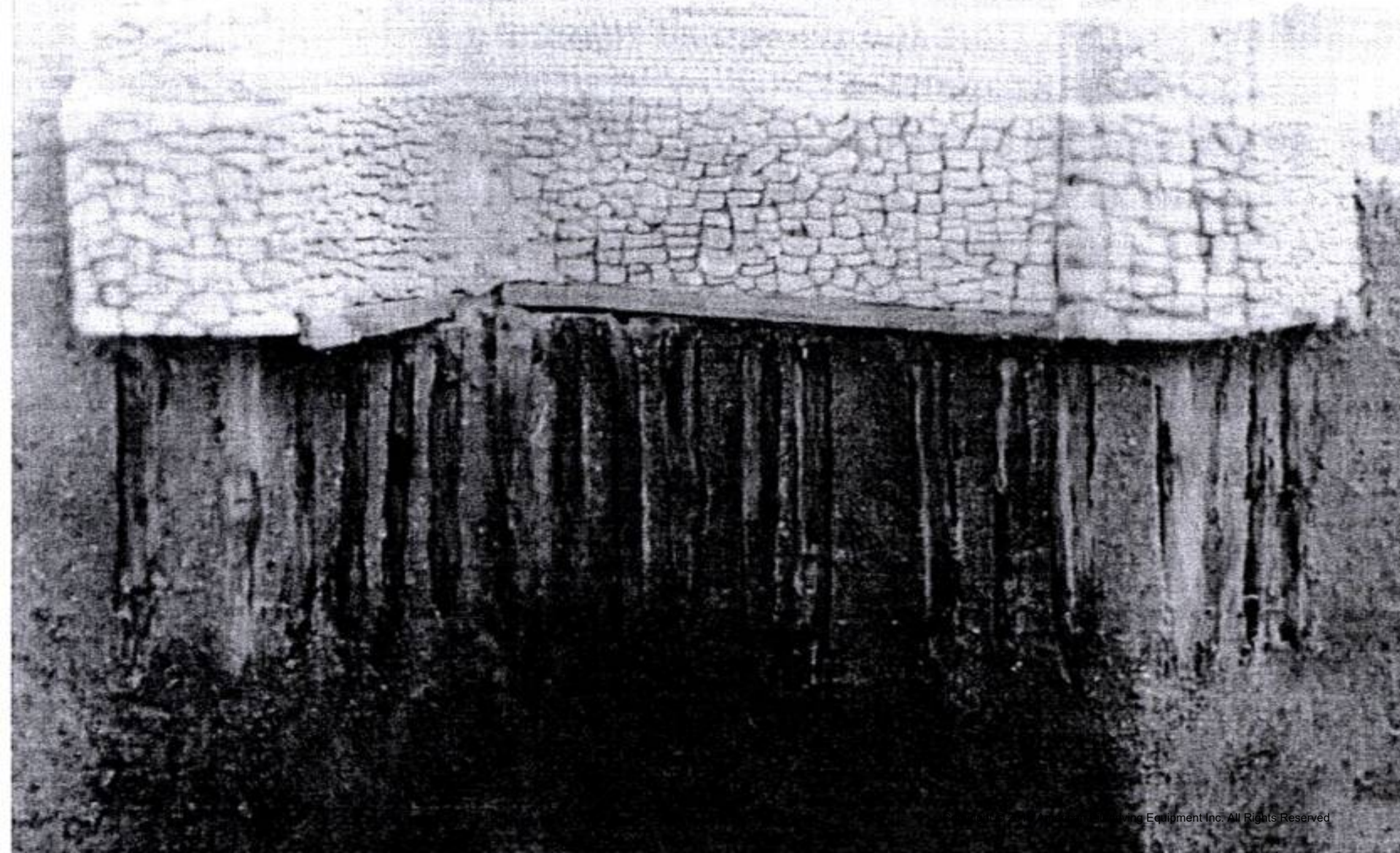



Layout of driven wood piles for Roman Circus of Arles

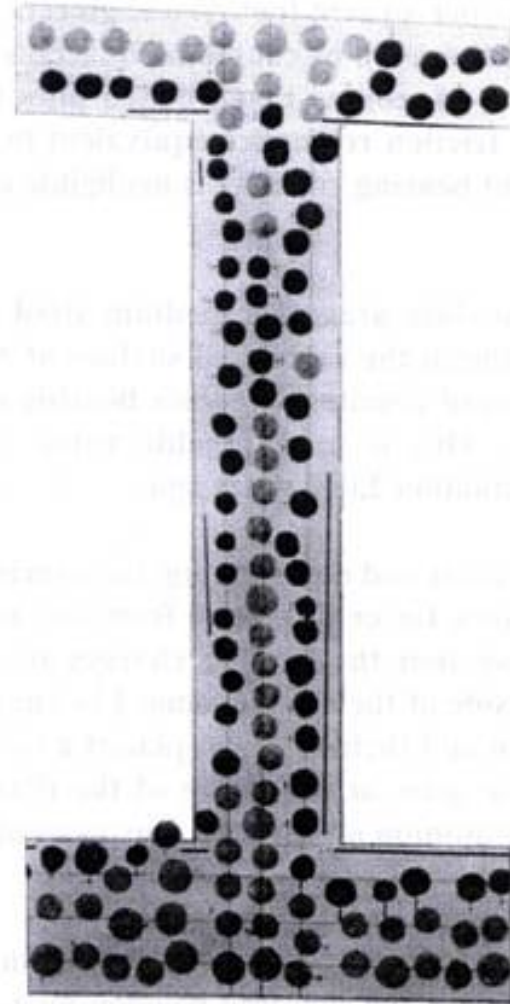

**RECONSTRUCTION OF THE PATTERN OF THE PILING
SYSTEM**



Modern wood piles, untreated.





Wood Piles
for false piles.
(untreated)
(Falsework)

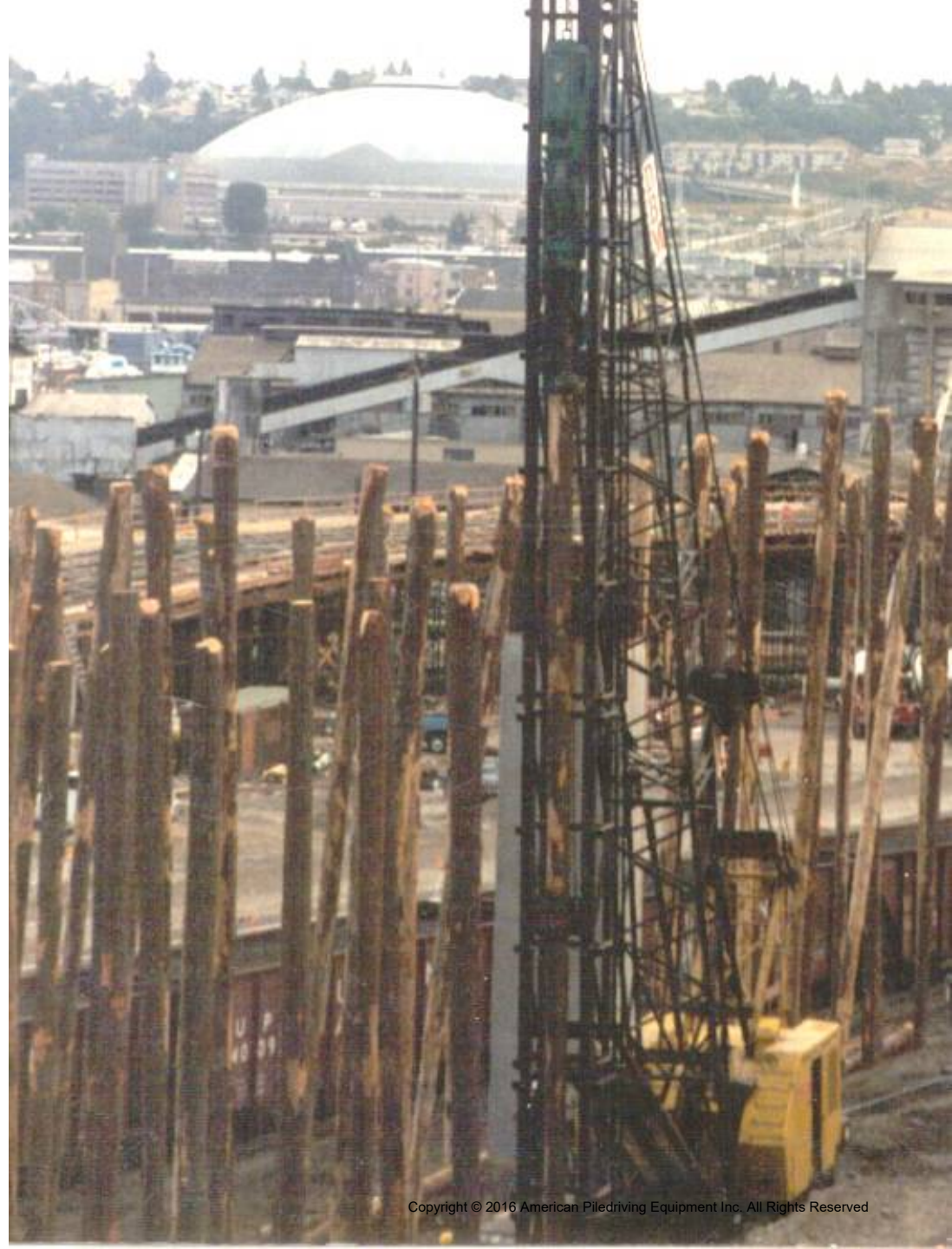

Wood Pile Seawall





Wood Piles

Wood piles are common on older docks on the waterfronts. They are banned in some areas due to creosote coating which is considered a health hazard.





Extracting wood piles

Things to know about wood piles:

Timbers should be treated if cut-off elevation is above ground water.

Piles should be straight. "Mother Nature" does not grow straight trees for piles, a guide is to stand at one end, sight the other end, and the line of sight (or a string line) should not depart from the pile. The deviation should be always less than half a diameter.

Timber piles are generally driven toe down.

Become familiar with the ASTM Standard D25 (Standard Specification for Round Timber Piles) as to diameter-circumference-length ratios, cracks, checks, knots, etc.

Ends of timber piles should be cut off perpendicular to the pile axis to minimize local contact stresses.

Things to know about wood piles:

- The pile head may require trimming to fit the helmet or insert.
- There are approved splicing techniques for timber piles. However, all are costly and do little toward resisting lateral loads. The general rule is to avoid splices.

H-Beams

H-piles are wide flange structural steel shapes having width and depth of similar dimension, and the same thickness for flange and web.



H-Beams for bridge piles in Salt Lake



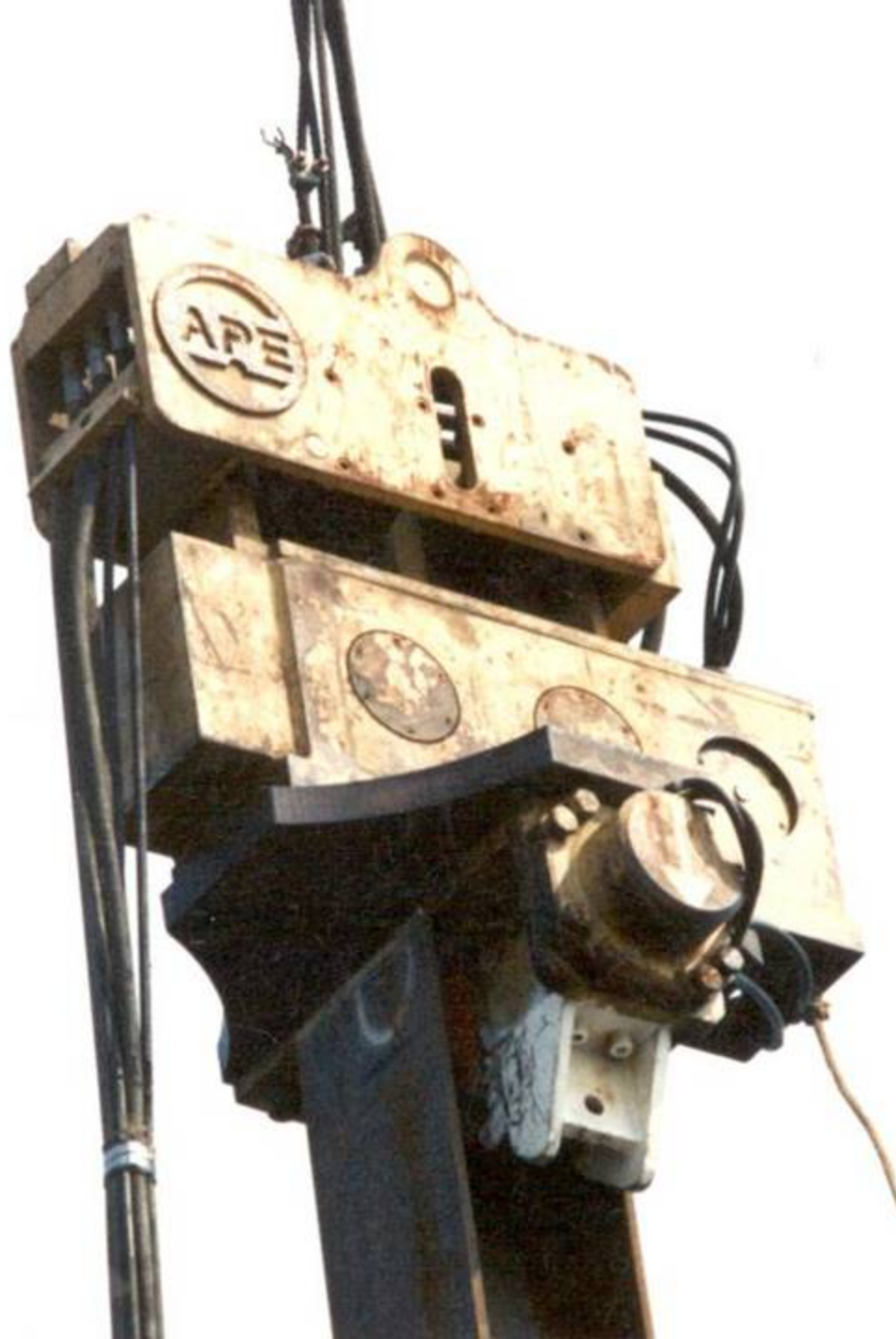

Driving
H-Beams
with a
vibro fitted
with a 90
degree
turning
plate



Driving H-Beams with a
double acting diesel
hammer mounted to an
H-Beam pogo leader





H-Beams being
driven using an
APE Model 200
vibro in Saudi
Arabia



H-Beams for retro-fit bridge work in California





H-Beams for oil storage tanks

**H-Beams
driven using
a unique
hydraulic
hammer
made in
Singapore.**





H-Beams for a building in Arizona

H-Beams being driven
inside a pipe pile to add
support to the pile
structure.





17 rigs drive H-Beams



30,000 H-beams for housing in Singapore.



Damaged H-Beams after extraction.



More damaged H-Beams.



H-Beam Filled with Clay

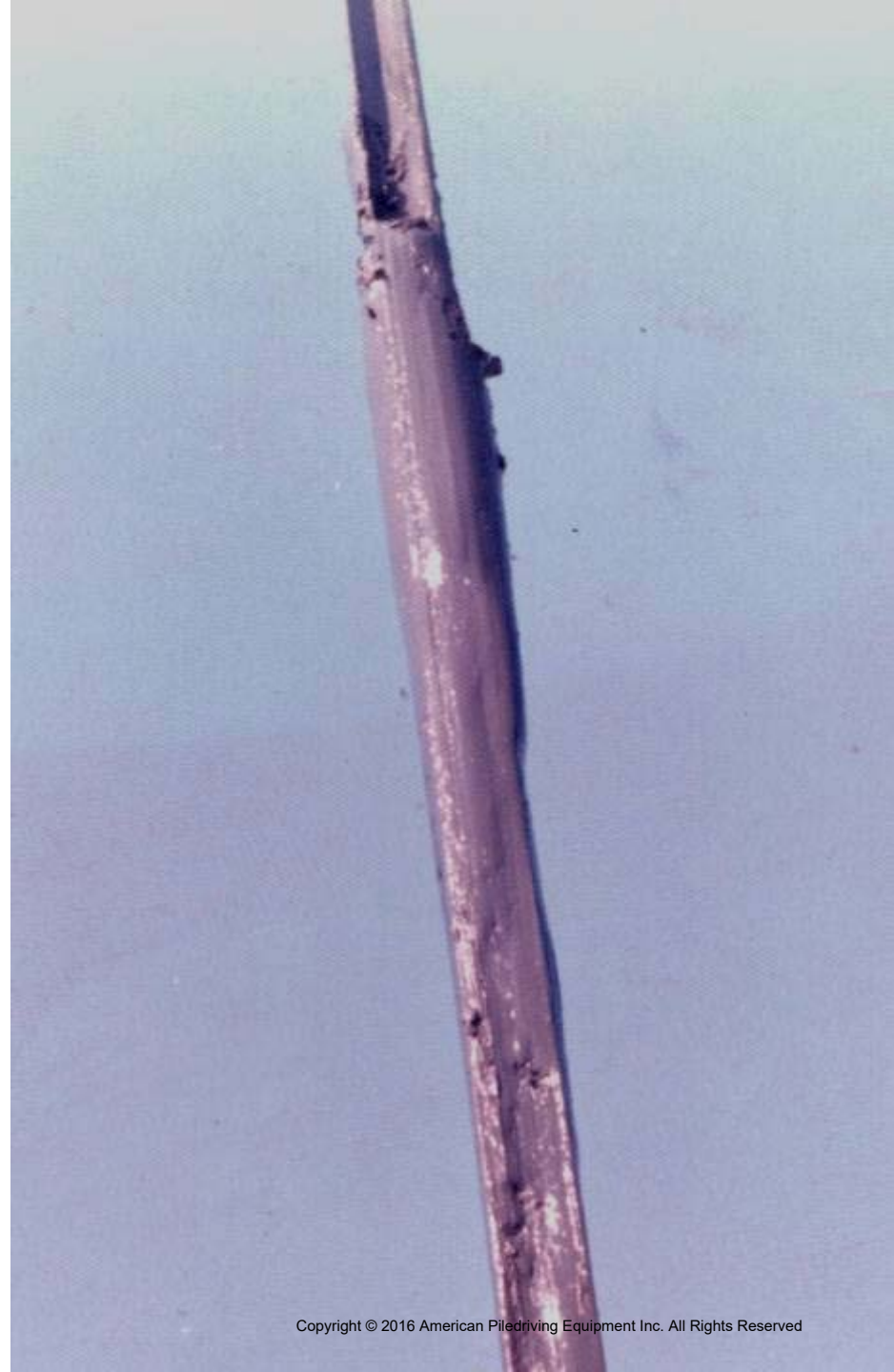

Steel Sheet Piles



Steel Sheet Piles

Interlocks for sheet piles



Ball and Socket (BS)



Double Jaw (DJ)



Single Jaw (SJ)



Double Hook (DH)



Thumb and Finger - three point contact (TF)



Thumb and Finger - one point contact (TFX)

Hook and Grip (HG)



SHAPE

This column describes the profile of the cross-sectional area. Sheet piling shapes in the Pile Buck® charts are grouped into four traditional shape classifications. These are:

Z-type (Z) used for intermediate to deep wall construction.

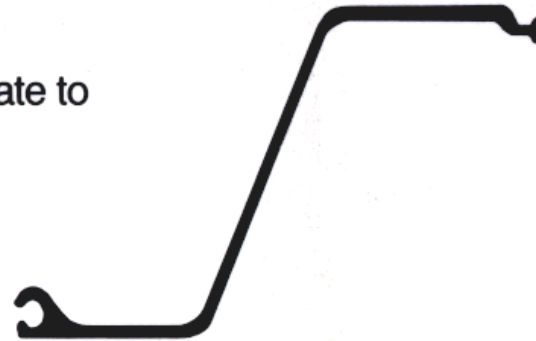

Sheet Pile Shape



Larsen and other “U” types (U) used for applications similar to Z-piles.

Flat or straight - web types (SA), (S) with strong interlocks, and little beam strength, for filled cell construction.



Arch shaped and lightweight “gauge” sheets (A) used for shallower wall construction.



Dimension terms you should know

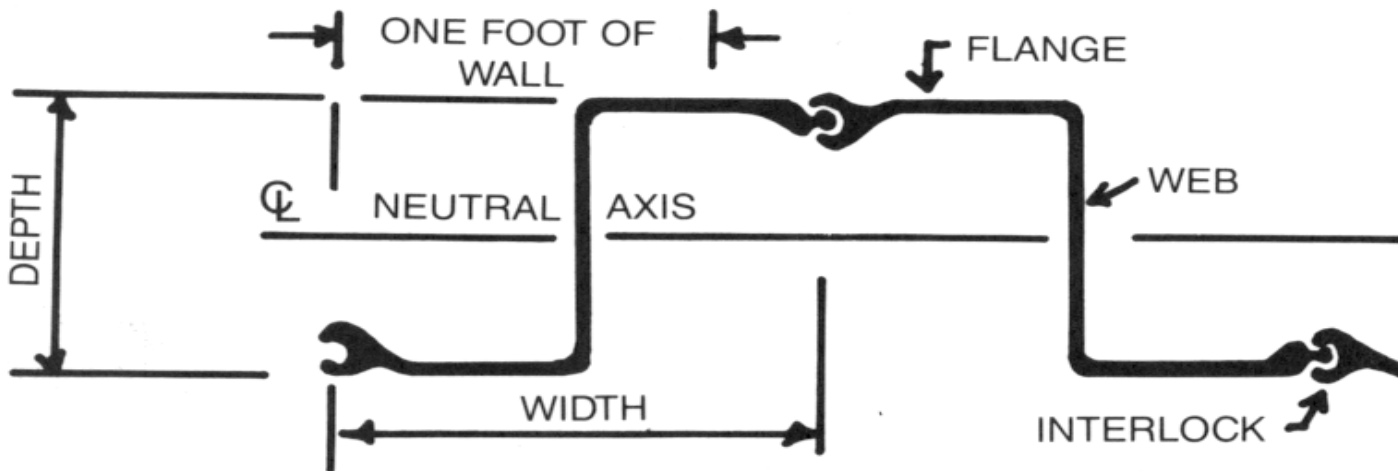
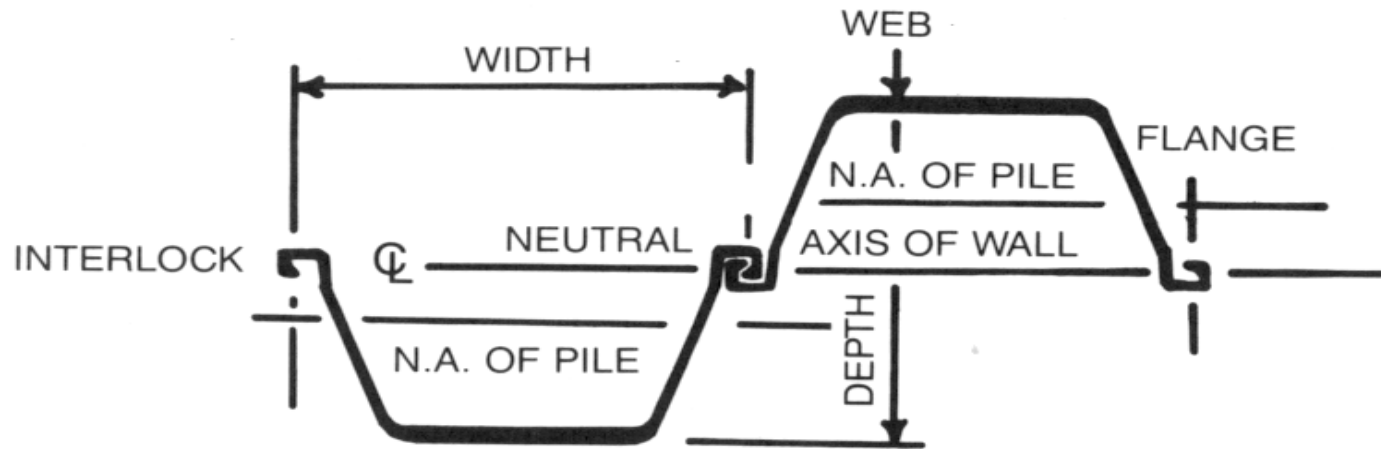



Sheet Piles Being Pressed in





Driving a sheet pile cell in California.

Flat steel sheets





Sheets for a dam project in Kentucky



Long, Flat Sheets





Long sheets being properly handled after extraction



A monster sheet pile cofferdam



Sheet piles for Air Force missile silos



Sheet piles to repair a river lock



Sheets for Shoring Pipe Lines

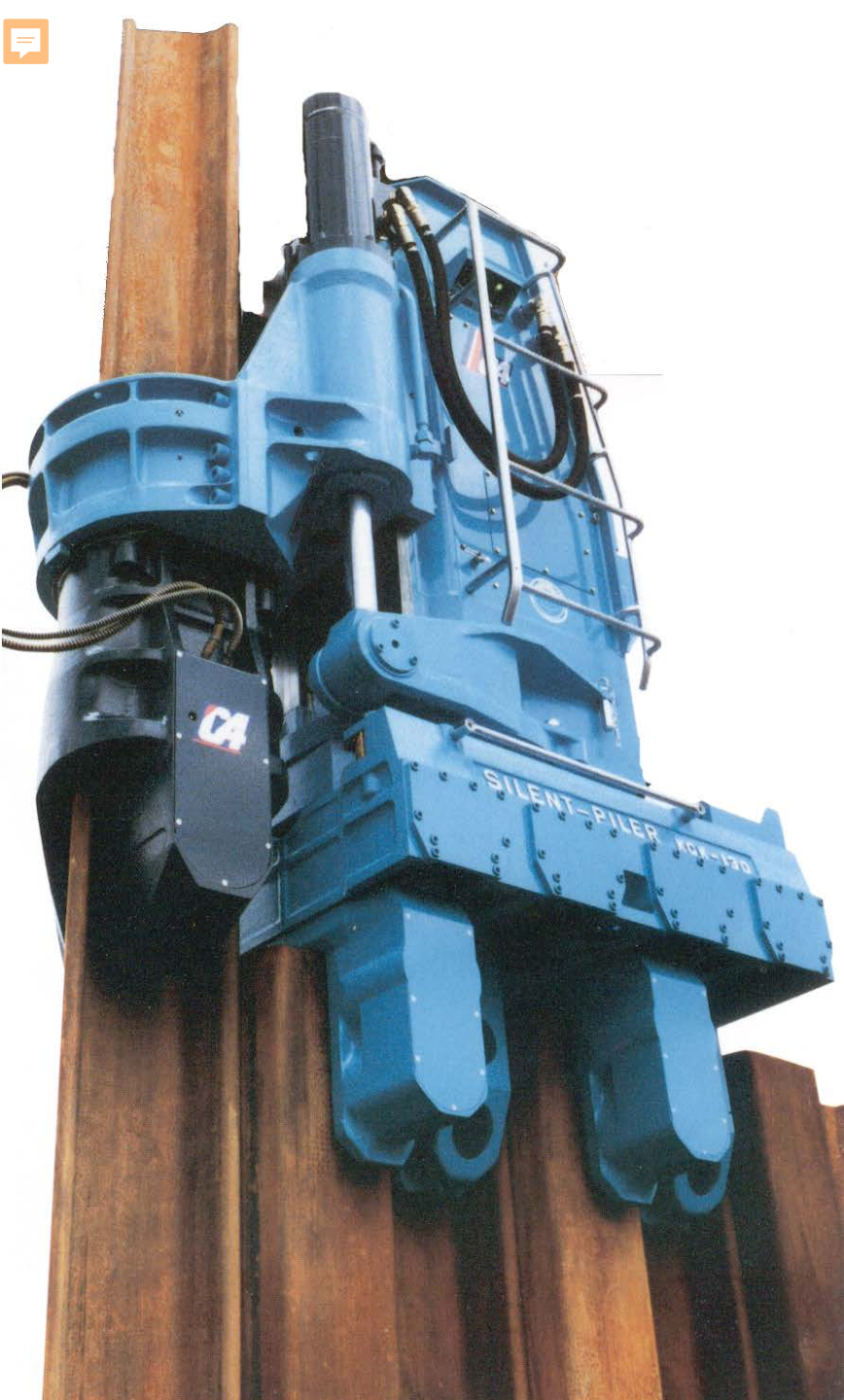

Sheet Piles





Driving sheets
with Press
Machine.

Setting Sheets
with Sheet Pile
Crane.



Sheet



AT-90 Type



TP-II Type



GP-F150 Type

H-Beam



Silent Piler for H-section Steel Piles Only



Silent Piler for Steel Tubular Piles Only



Steel Pipe Piler

Pipe

Sheet driving in steps with silent pile driver

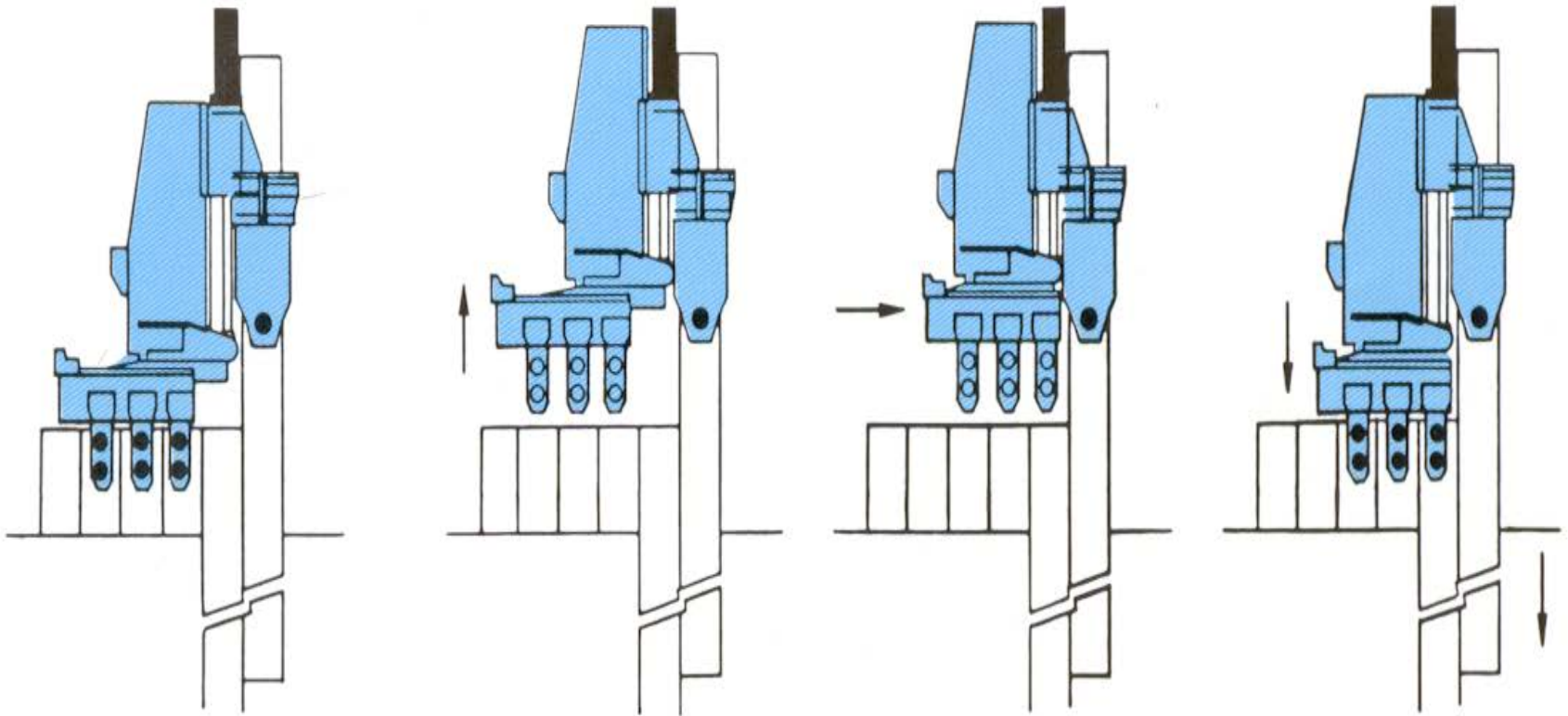

Temporary Sheet Piles



Steel Sheet Piles- Z Sheets



Sheet Pile Wall with Whalers





Sheet Piles PS 31 at Olmstead Lock



Stacked Sheet Piles

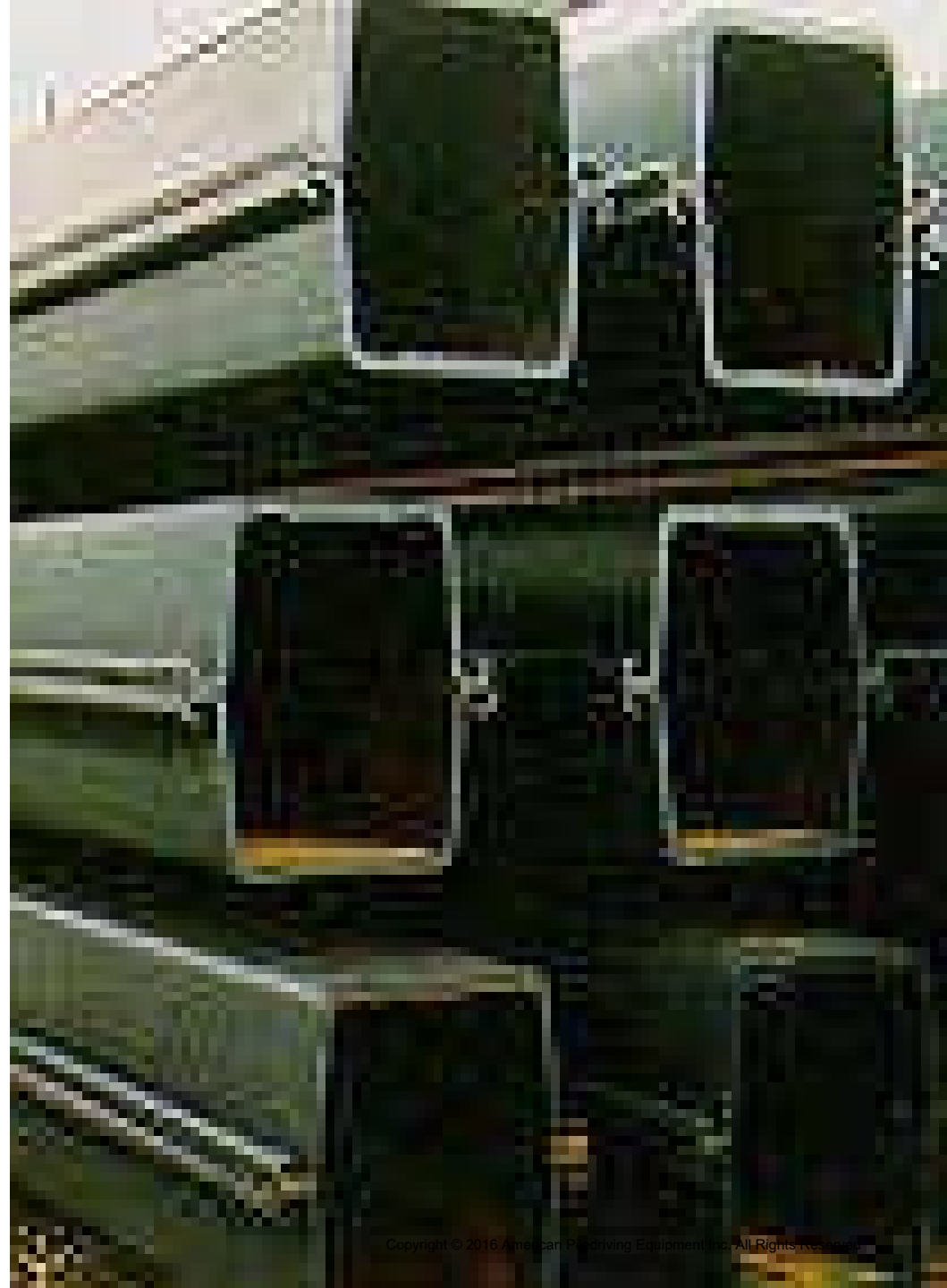

Square Concrete Piles



Square Concrete Piles





Square Concrete
Piles being Driven
by a Twinwood
Hydraulic Impact
Hammer.



Square piles damaged by ship

Square Concrete Piles



Square Concrete Piles





Extracting Square Concrete Piles



Square Concrete Piles





21 inch square pile being pressed into the ground



Square Concrete Piles

Square Concrete Piles

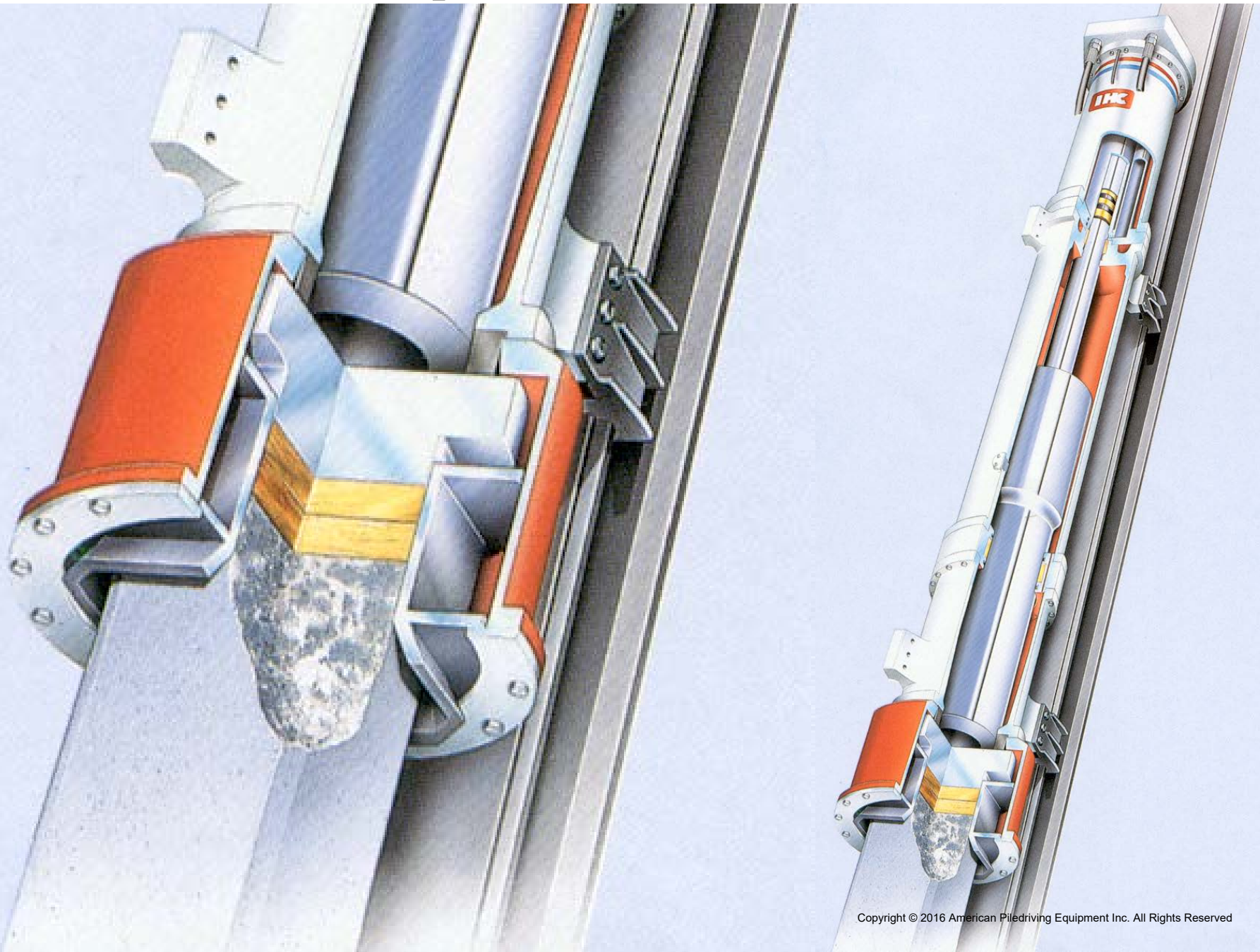

Octagon Concrete Piles

Driving Concrete Piles



Octagon Concrete Piles



Octagon Piles in Hawaii



Concrete Octagon



Extracting Octagon Concrete Piles



Concrete Octagon Piles





Octagon piles ready for final pour

Concrete Pipe Piles

Concrete Pipe Piles





Concrete Pipe (Spun)



Concrete Pile Piles Driven with a Flying Hydraulic Impact Hammer





**Concrete pile
being cut with a
special cutter**

World's Largest
Driven
Concrete Pile
1953
15 foot diameter
120 foot long

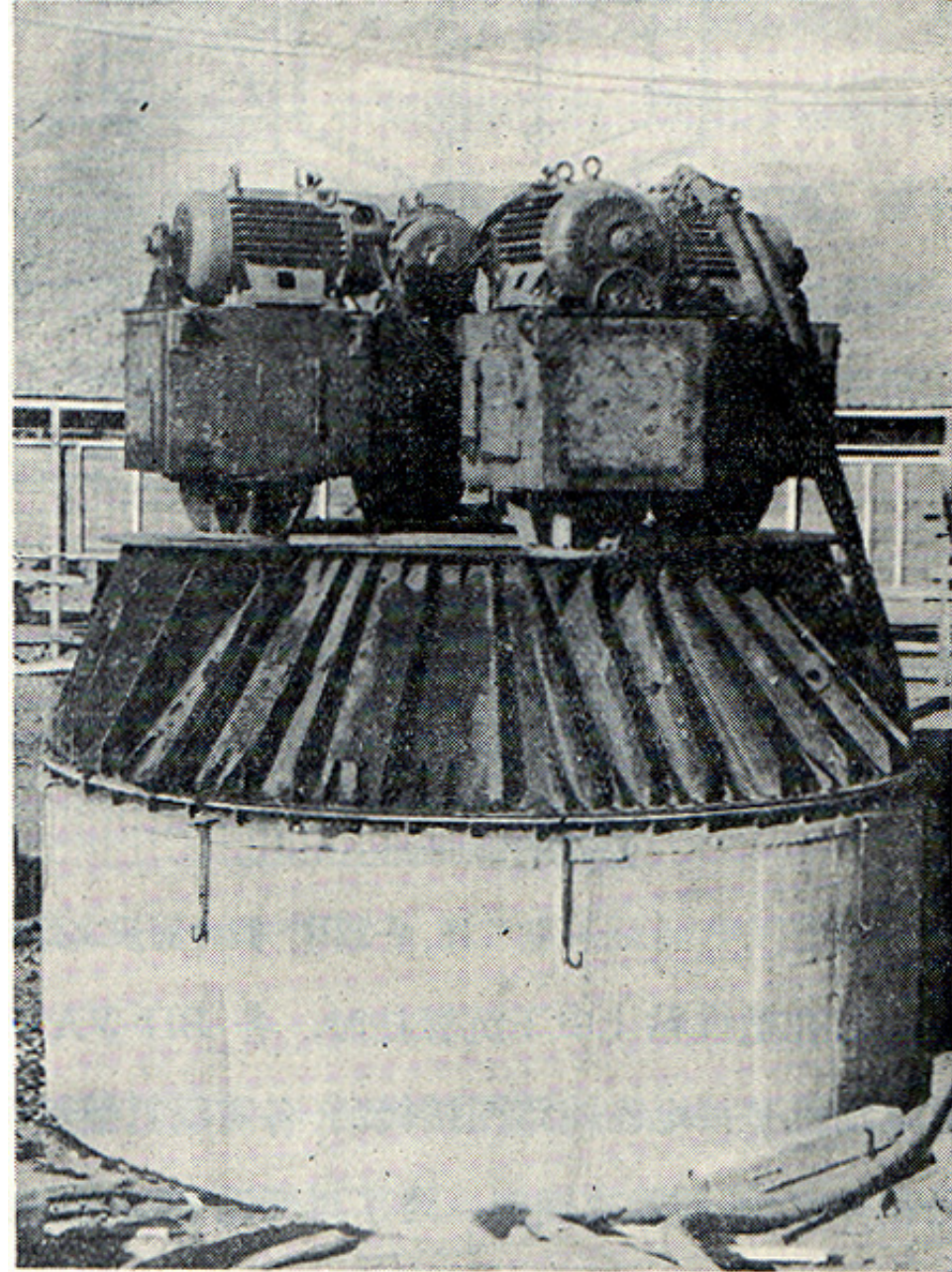

Four Russian Vibros

Concrete Sheet Piles

Concrete Sheet Piles





Concrete Sheet Piles

Concrete Sheets

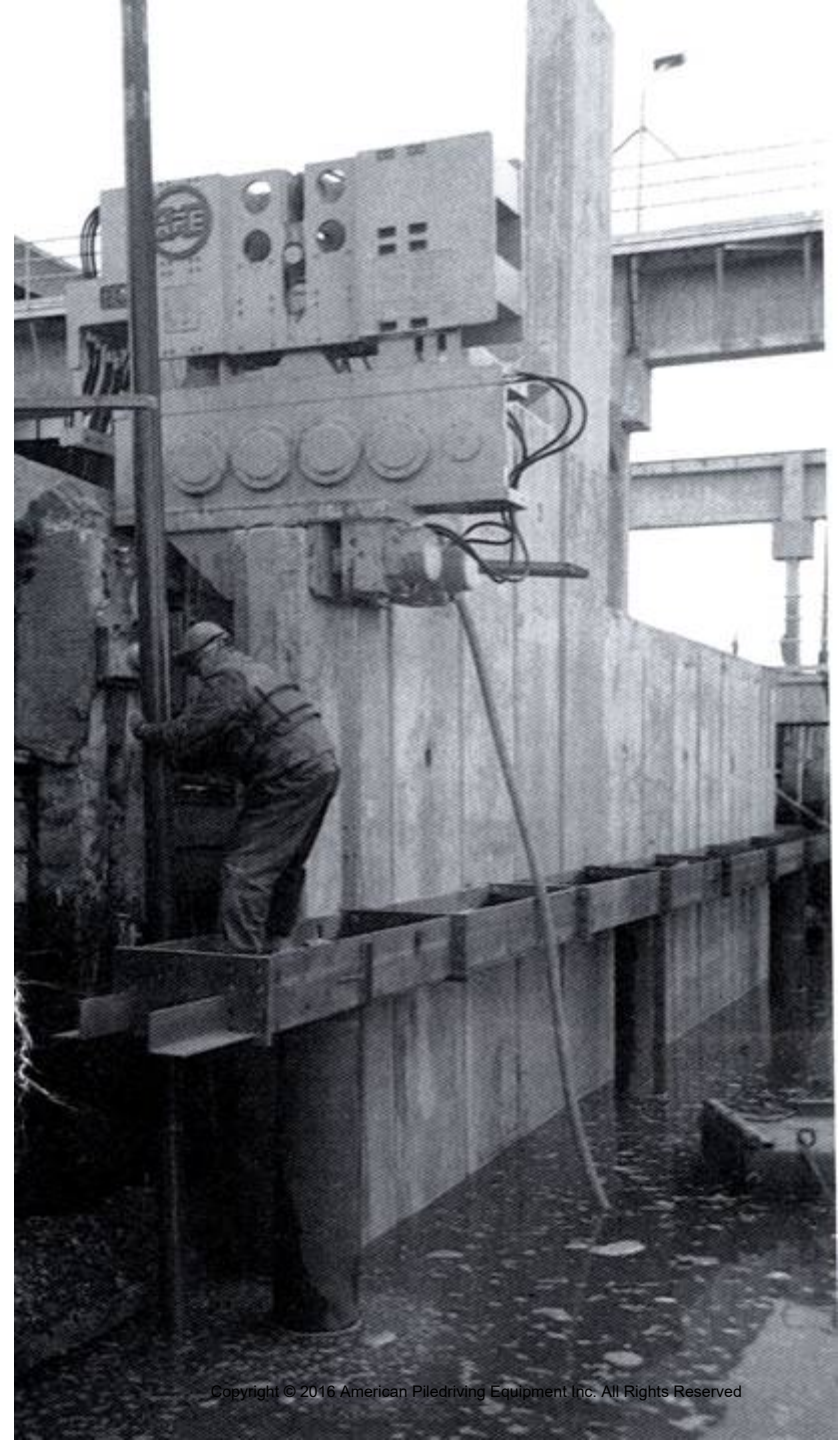

Concrete Screw Pile

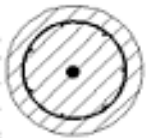
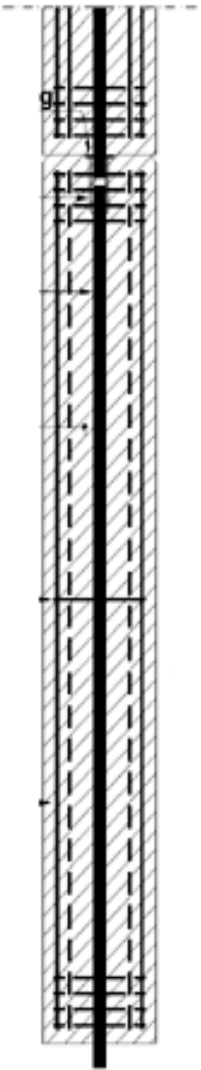

Steel Pile Piles



Large diameter pile piles for a bridge in Vancouver, B.C.



Pipe Piles inside a sheet cell

Spliced pipe
piles under a
bridge using
twin vibros



Forklift lead system - Fraser River Pile



Pipe Piles

Junttan HHS9 driving 100 foot long piles in a series of splices under a bridge in California.



Excavator mounted leader system



Steel Pipe Piles



Closed Ended Pile





Menck Driving Pipe Piles





Spiced Pipe Piles being driven under a bridge in California





Pile Piles being driven with a flying hammer





Pipe piles used to protect a river bank from ice flow damage in Bethel, Alaska



Pipe Pile Covered with Clay During Extraction





Junttan Hydraulic Hammer Driving Pipe Piles in Salt Lake City, Utah USA

King Piles

King Pile



Power Pole Foundations

Power Poles





Power Pole Foundations





Power Pole Foundations

Power Pole Foundations



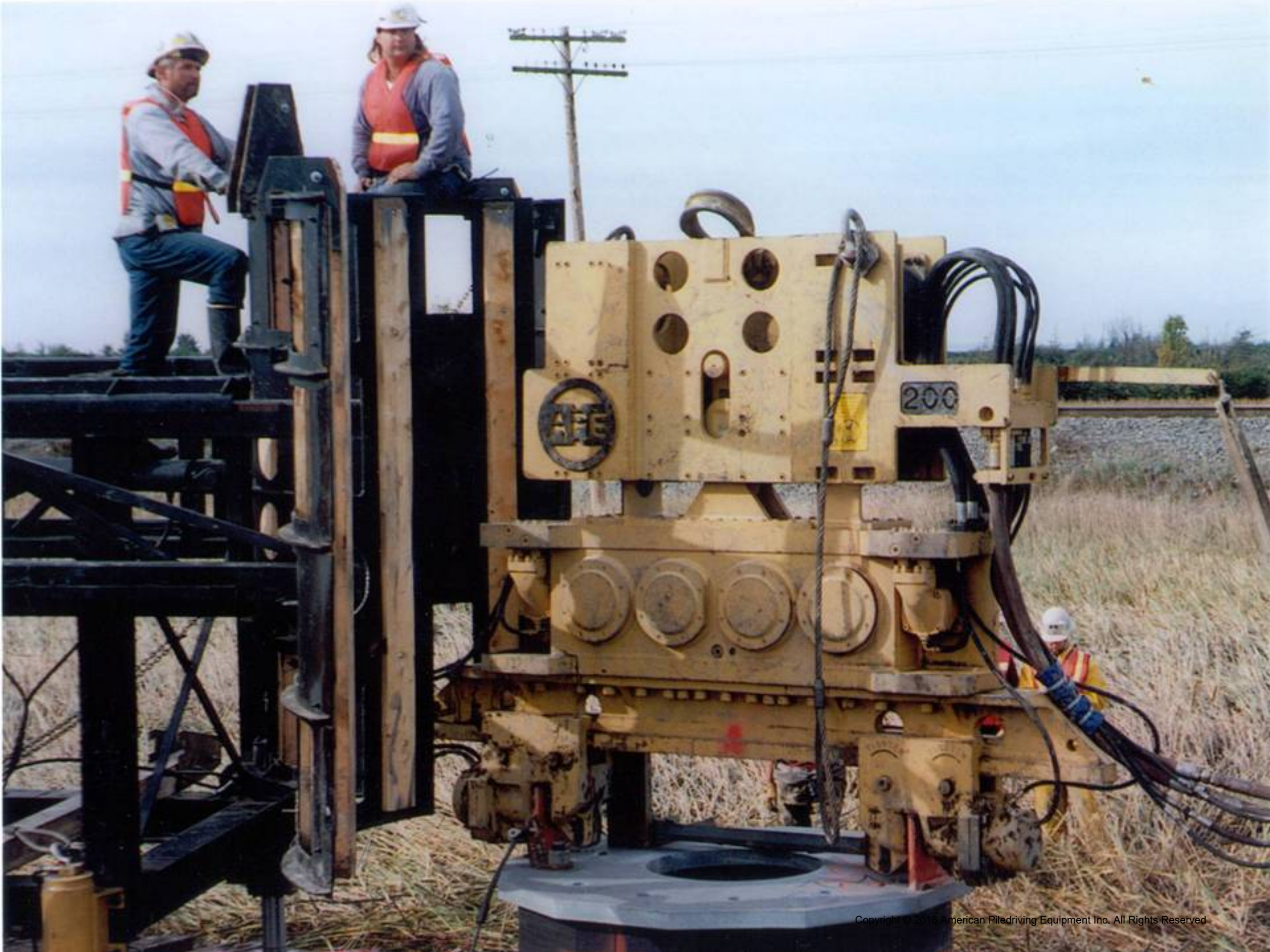



Power Pole Foundations

**APE Model 200
drives power poles
while suspended
from a helicopter.**





Power Poles are usually twelve sided

Mini Piles



Mini Piles

Shell Pile



Mandrel driving steps for shell piles

1. Mandrel is inserted into pile shell and expanded.

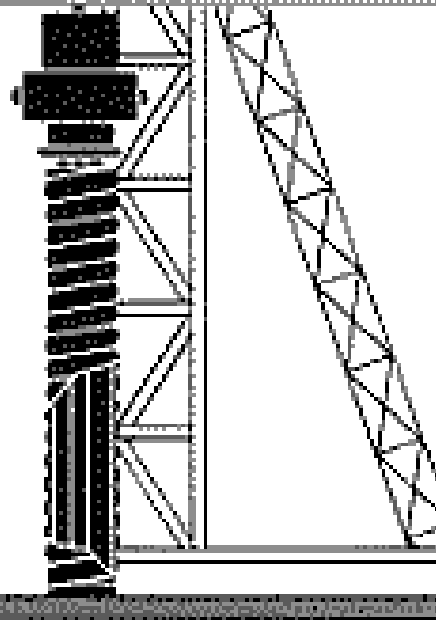

2. Mandrel and pile shell are driven to required tip elevation.

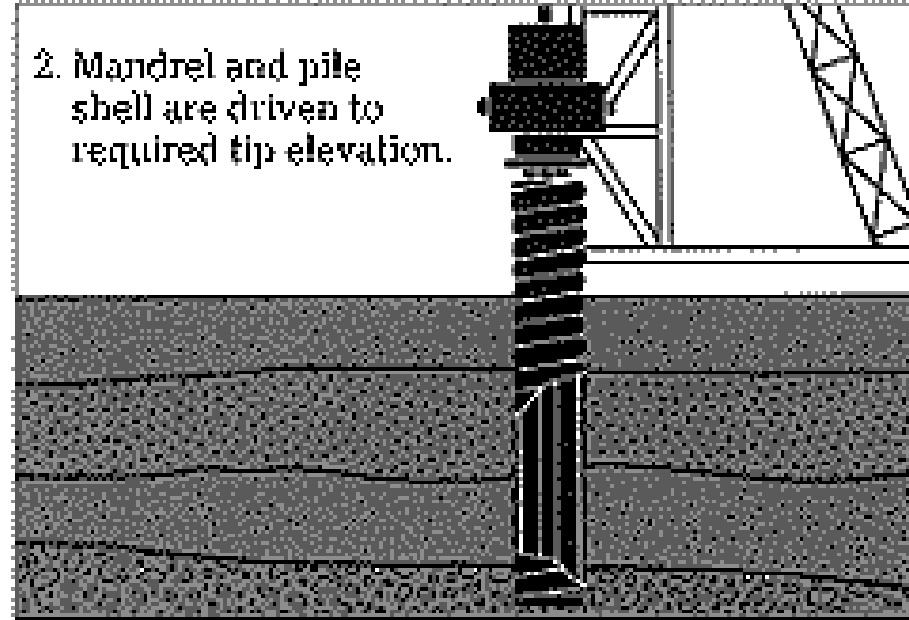

3. Mandrel is contracted and removed, leaving pile shell in place.

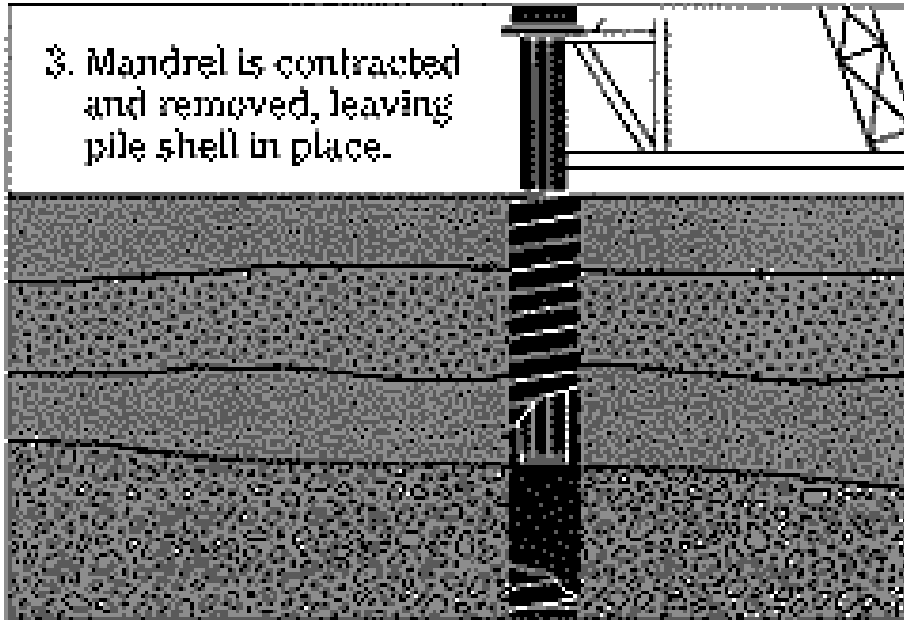

4. Driven shell is inspected and filled with concrete.

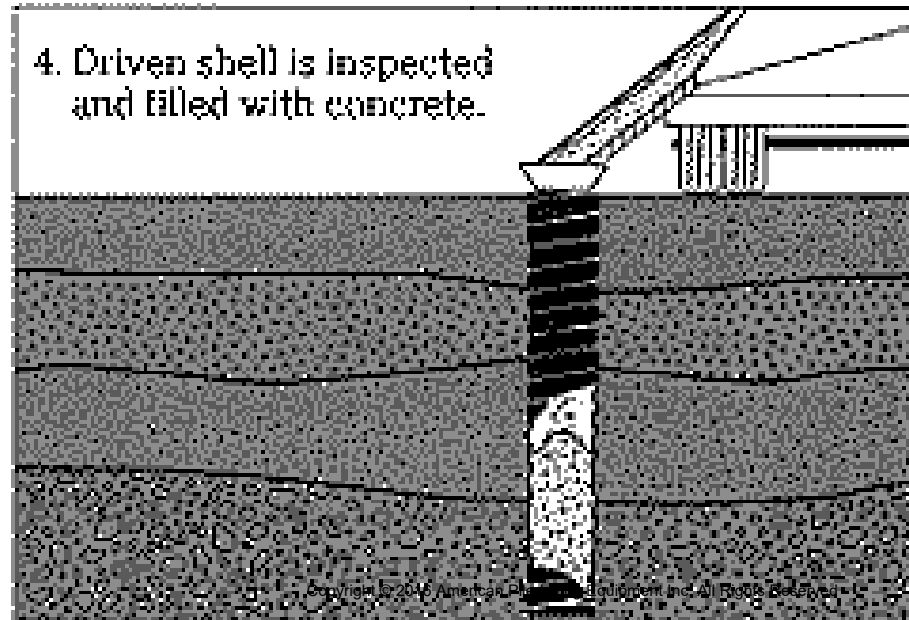

Expanding Anchor Pile

Expanding Anchor Pile



Casings and Caissons

Driving 36 inch cans with a High Frequency APE Model 200 HF







Large Casings

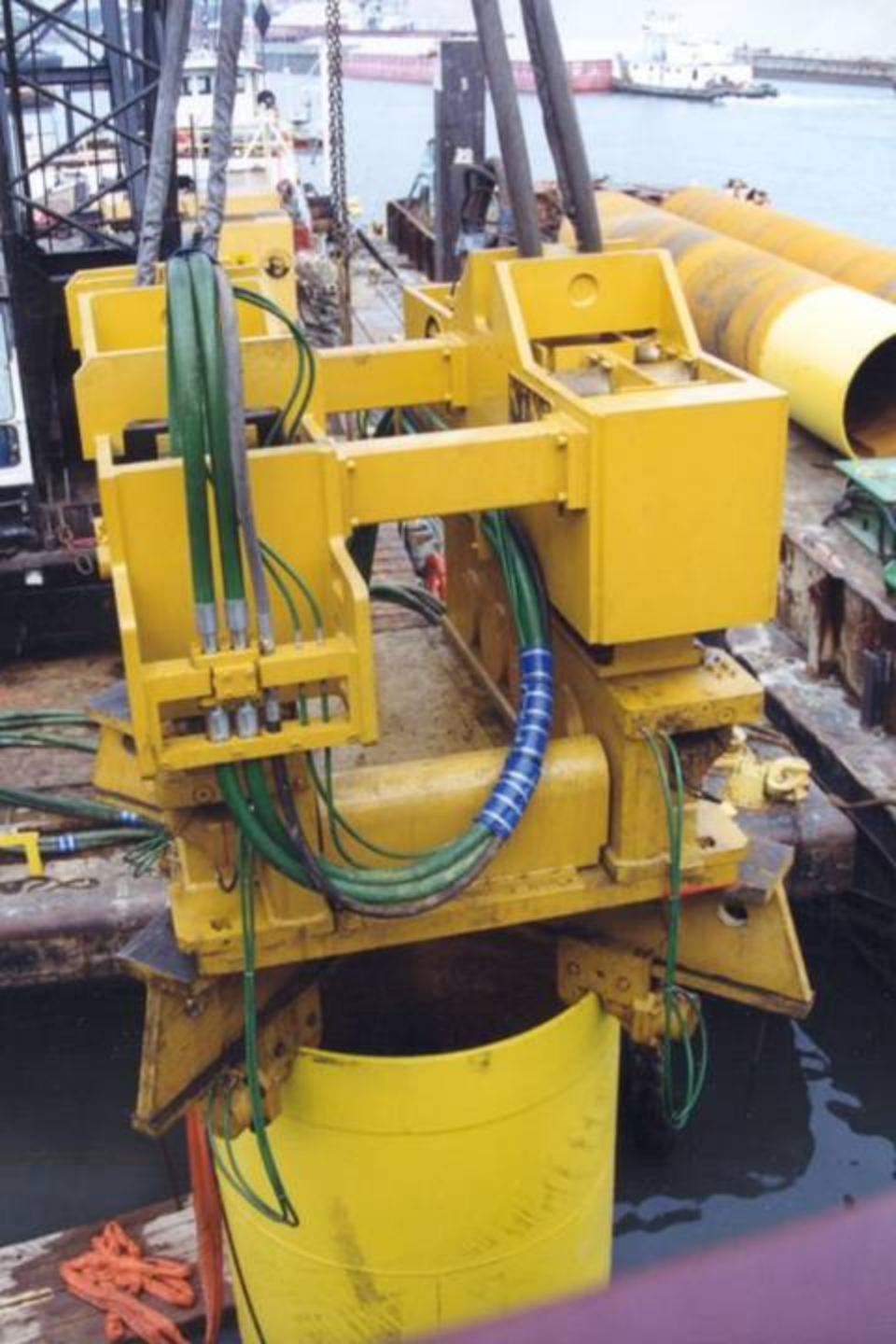

Large Diameter Piles

Twin APE King Kongs
Driving 8 foot caissons.

Large Diameter Casings with Rebar on Top



Plastic Sheet Piles

Plastic Sheet Piles



Plastic Sheet Piles





Heavy duty plastic sheets



Composite Piles



Composite Piles

Fiberglass Tubular Piling

- Strong
- Durable
- Warrantied Performance
- Non-polluting

- Fender pile
- Bearing piles
- Dolphins



Tapertube piles



Tarpon Piles



Tarpon Piles

APE King Kong driving Tarpon piles 400 feet under water

GPS system mounted on top of vibro.

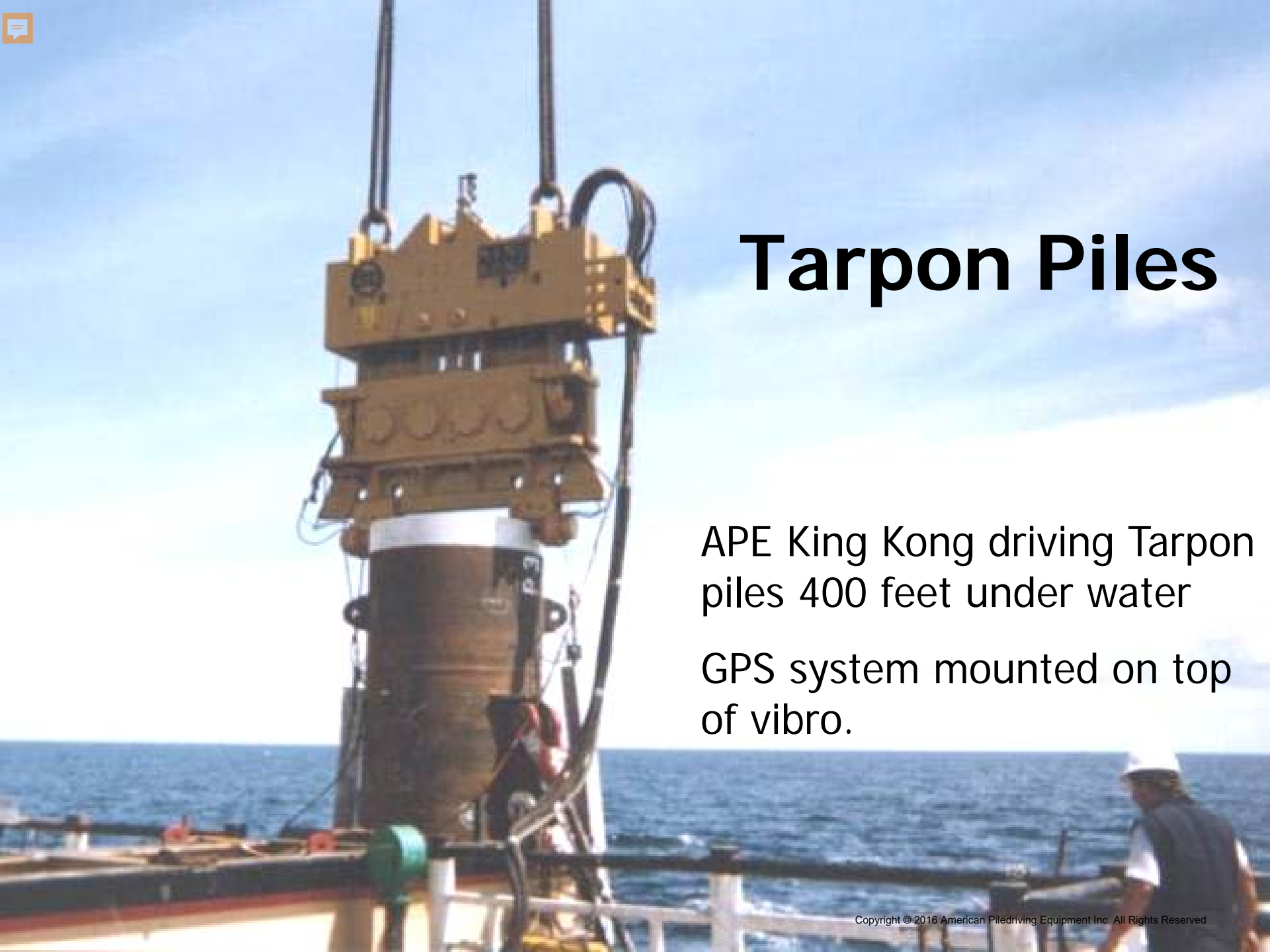

Conductor Piles



Conductor Pipe For Oil Exploration

APE Model 200 extracts 250 foot long conductor pile on North Slope.

Monotube Piles

Monotube Piles

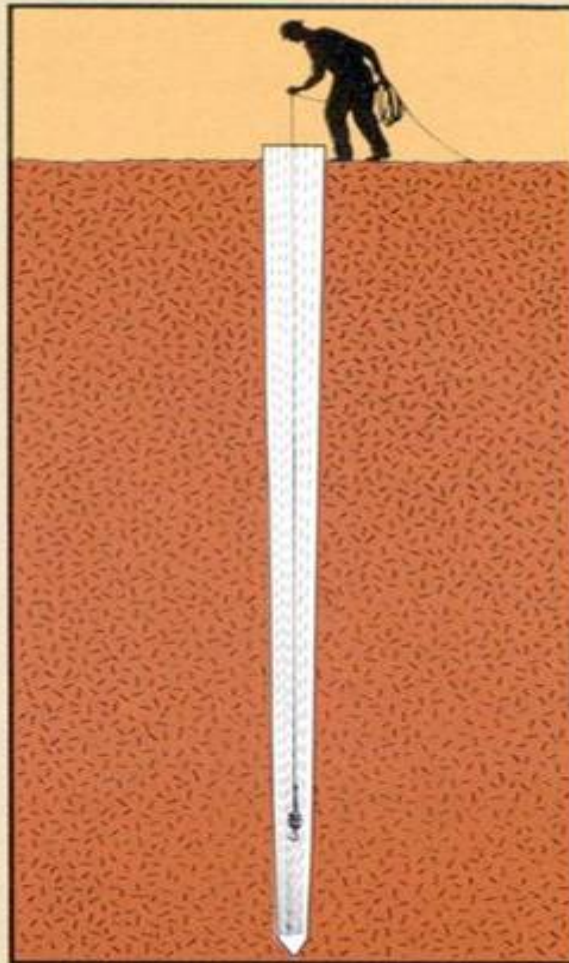
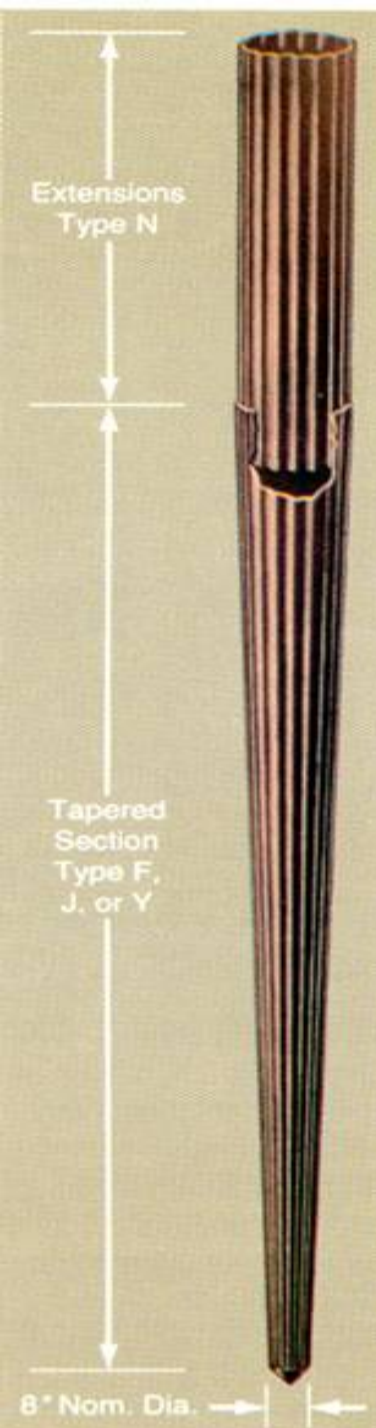





Monotube piles can simplify design and greatly reduce construction costs when





Followers

Steel follower



Close up view of top of follower



Followers:

For Optimum Energy Transfer the Impedance (“dynamic stiffness”) of the follower should match that of the pile.

$$(EA/c)_{pile} \approx (EA/c)_{follower} \quad (\text{Equation 1.})$$

where E= Young’s Modulus, in kips/square inch,
 A= Cross-sectional area, in square inches
 C=material wavespeed

Using this approach the area of a steel follower for a concrete pile would be about 20% of the area of the concrete.

Followers:

A Follower must be TOUGH, and it is not uncommon to nearly double the Impedance, or Area, of a follower from that suggested by Equation 1, even though this causes a reduction in driving Efficiency.

Because a follower is reused, follower design must consider *fatigue strength* of the material and weldments.

Wave Equation Analysis is an effective tool for predicting stresses and driving efficiencies for various proposed configurations

Dynamic measurements with a PDA may provide useful information and may help to calm concerns surrounding follower use.

Pile Points, Splicers, and Boots

Pile points and splices

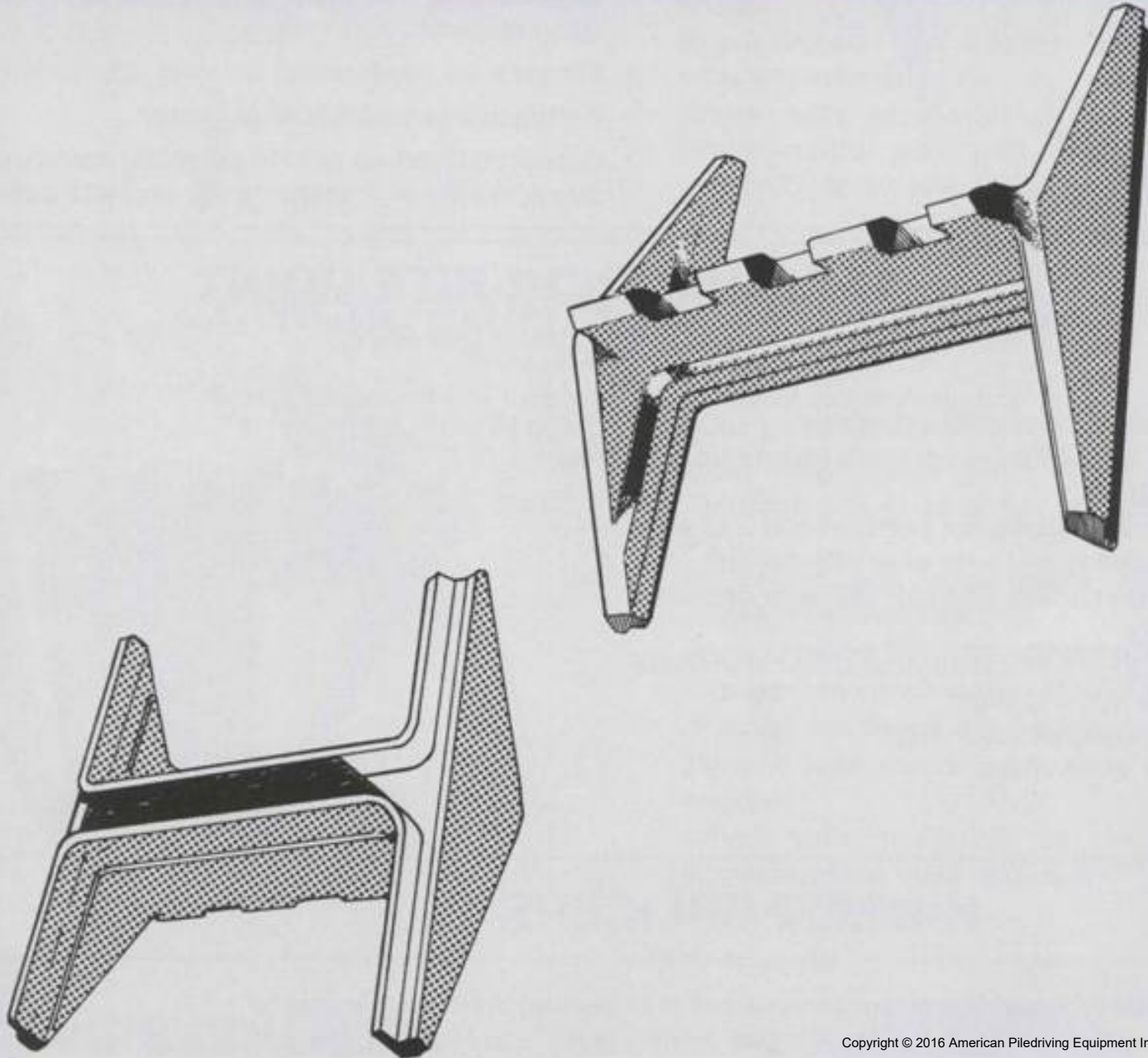

H-Pile Points

ACCESSORIES: H-PILE

THE SUPER-BITE POINT

Model #: PAR-T (Regular Points)

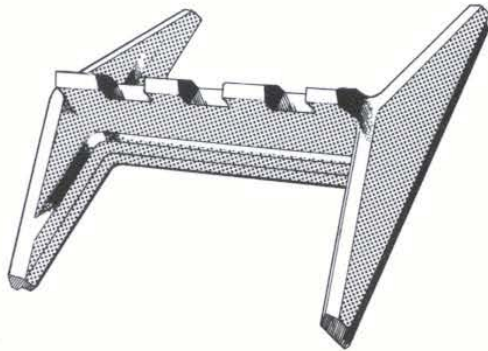

- **Four large cutting teeth on the web section for better gripping in rock formations.**
- **Continuous cutting edges on the flanges.**
- **Continuous backing for both flanges and web.**
- **Thicker flanges and web sections.**
- **Meets ASTM A27 standards. Other standards available upon request.**
- **Flanges are pre-beveled for easy attachment.**
- **Certifications with EACH shipment.**
- **Accepted/Used on private projects, municipalities, and Departments of Transportation projects coast-to-coast.**

H-Pile Points for Rock

THE SUPERIOR-BITE POINT

Model #: PAH (Heavy Duty Points)

- Extra heavy for special use areas.
- Thicker web & flange sections (minimum 1.5 times beam sizes).
- Continuous backing for both flanges and web.
- Pre-beveled flanges for easy attachment.
- Extra large cutting teeth for superior gripping capability.
- Meets ASTM A27 standards. Other standards available upon request.
- For special application use.

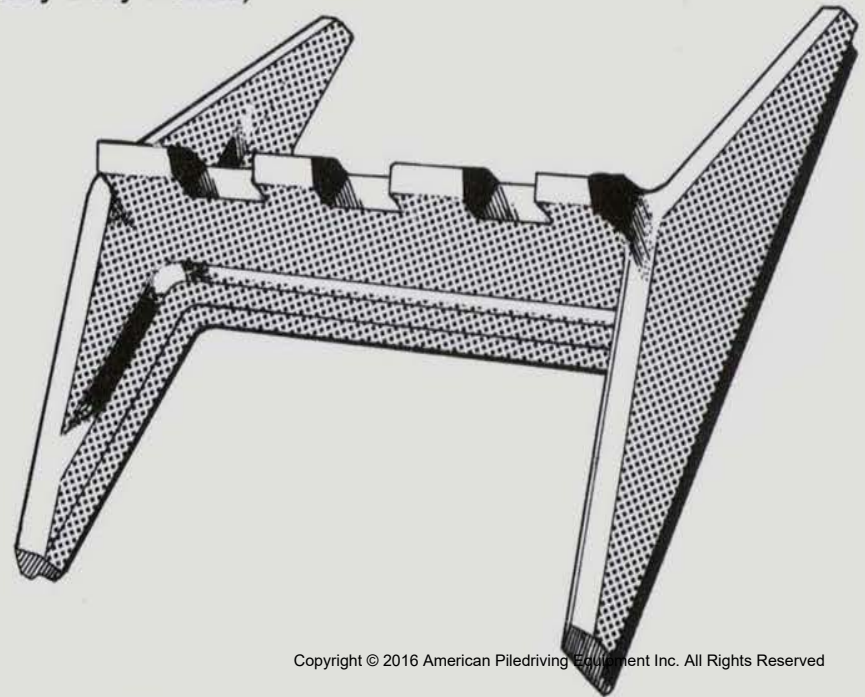

H-Beam Splicers

H-BEAM SPLICERS

Model #: PHS

On many pile jobs where splices are required in H-Beams, the time required to make the splice can equal or exceed pile driving time. PAI H-Beam splicers substantially reduce splicing time in two ways. First, pile alignment is quick and easy as the splicer also serves as the welding template. The splicer slips over the driven pile section and the new section easily slides onto the web of the splicer providing quick and accurate alignment. Second, welding time is greatly reduced - often up to 75% as only a fraction of the weld is required.

WELD PROCEDURE

Chamfer outside edges of flange on ends of both piles to be spliced. Make chamfer equal to about 1/2 material thickness. Cut a rectangular notch in the web of one pile approximately 1" x 3" to accommodate the connecting lug. Insert splicer on first beam making sure lug is completely inside notch so that lug does not interfere with seating of the next pile. Using a 70xx series rod, weld the flanges of the splicer to the flanges of the beam with 5/16" x 2 1/2" fillets. The weld should be on the sides of the splicer near the ends. (Do not weld the web or the end of the splicer.) Install next section of pile and repeat welding. Weld the outside flanges of the pile and your splice is complete.

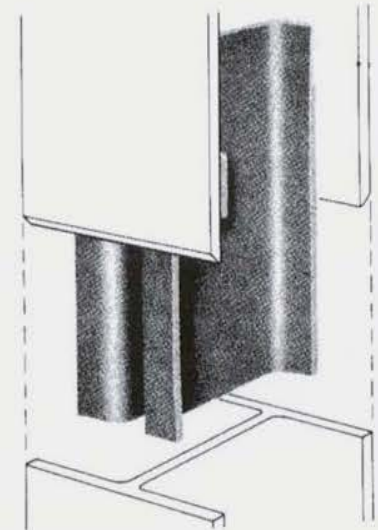

Cutting Shoes- inside or outside

ACCESSORIES: PIPE PILE

CUTTING SHOES FOR PIPE PILES

Model #: PACI (Inside Fit) - PACO (Outside Fit)

Cutting shoes are available for open-end piles, caissons and well pipes.

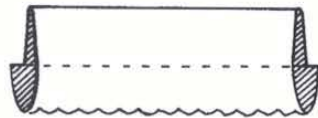
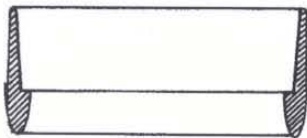

- Protects pile tip during driving.
- Allows seating into rock without pile damage.
- Cast from tough alloy steel (ASTM A27).
- Open end makes driving easier.
- Open end allows drilling below pile tip if required.
- Driving force directed to flat ledge of shoe.
- Tapered lead allows quick, easy installation on pipe.
- Pre-beveled for easier and quicker attachment on the job.
- Attach with friction fit or single, simple circumferential weld with a 5/16" fillet weld using a 70 series rod.

Conical Points for Pipe Piles

Model #: PAC 60 Series

Where maximum pile bearing and minimum soil disturbance are required, the PAI conical pipe pile point fills the bill.

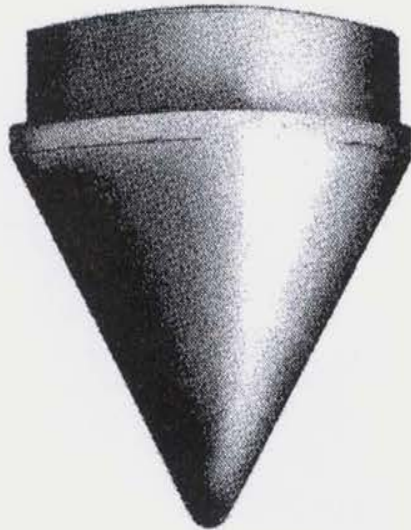

- Most dependable pile point protection.
- Distributes load over full circumference of pipe.
- Minimizes soil disturbance resulting in maximum friction bearing.
- Allows seating into rock without pile damage.
- Cast from tough alloy steel (ASTM A27).
- Driving force directed to flat ledge of shoe.
- Tapered lead allows quick, easy installation on pipe.
- Attach with friction fit or single, simple circumferential weld with a 5/16" fillet weld using a 70 series rod.

Pipe Pile Couplers

PIPE COUPLER

Model #: PAC Series

Made of cast steel for uniform sizing - no risk of improper fit as with fabricated splicers that are individually made. Drive fit requires no welding.

WELD PROCEDURE

Pipe splicers are drive fit and do not require welding. Under proper conditions, the drive fit is water tight. If welding is desired, a simple 5/16" fillet using 70xx series rod at the top and bottom is all that is required.



Timber & Sheet Pile points

ACCESSORIES: TIMBER & SHEETING

TIMBER PILE POINTS and BOOTS

Model #: PAT Series (Points) - PAB Series (Boots)

If soil data indicates possible pile damage due to obstructions or a stiff layer which must be penetrated, PAI timber pile points provide the required assurance that the pile will reach required bearing in good condition.



- Prevents pile splitting and brooming.
- Quick and easy to attach.



- Available for all timber pile sizes.
- Made of ASTM A36 steel plate.

Sheet Pile Protectors

SHEET PILE PROTECTORS

Model #: PASP Series

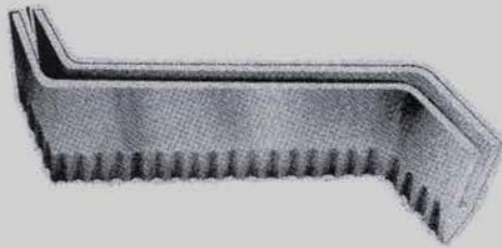

Your choice of our "universal" sheet pile protector to fit all piles or our wide selection of "Z" protectors are made to fit each of the most popular sheet piles used.

One piece cast steel sheet pile edge protectors help insure pile penetration and at the same time provide significant protection for the leading edge of the pile.

- Edge fluting aids in keeping pile vertical while driving.
- Wedge shape opens slot to ease driving and reduces abrasion of pile coatings.
- Strong cast steel (ASTM A27 minimum) shoe protects pile edge from damage.

WELD PROCEDURE

These points should be welded with a 5/16" fillet along the entire length of the top flange on both sides using 70xx series rod.

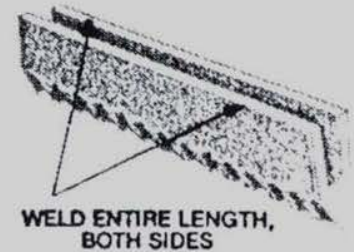

Backing Rings and Pipe Caps

ACCESSORIES: PIPE

BACKING RINGS AND PIPE CAPS



BACKING RINGS: Carbon Steel, 1" - 36" O.D. in stock with short nubs (5/32") or long nubs (3/4"). Sizes up to 60" O.D. available.

PIPE CAPS: 1/2" - 42" O.D. in stock with special order sizes up to 72" O.D. Made from 18 to 22 gauge steel depending on size of O.D.